



DENTAL instruments
Catalogue

	<p>01</p>	<p>Extracting Forceps Page 01-31</p>
	<p>02</p>	<p>Root Elevators Page 32-50</p>
	<p>03</p>	<p>Filling Instruments Page 51-55</p>
	<p>04</p>	<p>Dental Probes Page 56-59</p>
	<p>05</p>	<p>Periodontia Instruments Mallets Page 60-67</p>
	<p>06</p>	<p>Curettes Scalers Page 68-74</p>

TABLE OF CONTENTS

<p>Page 75-77</p> <p>Modelling Instruments Measuring Instruments</p>	<p>07</p> 
<p>Page 78-79</p> <p>Wax / Plaster Knives</p>	<p>08</p> 
<p>Page 80-85</p> <p>Diagnostic (Explorers) Endodontic Instruments</p>	<p>09</p> 
<p>Page 86-87</p> <p>Excavators</p>	<p>10</p> 
<p>Page 88-89</p> <p>Handles For Mouth Mirrors Mouth Mirrors</p>	<p>11</p> 
<p>Page 90-93</p> <p>Spatulas</p>	<p>12</p> 

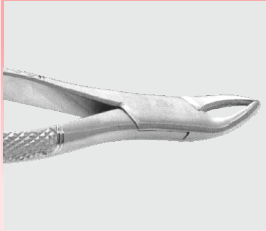
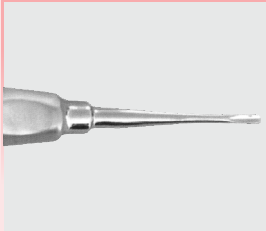
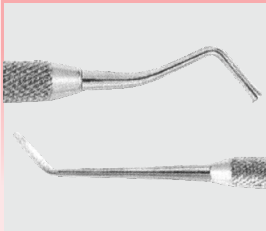
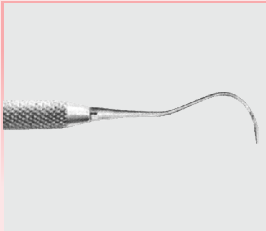
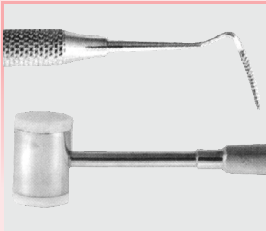
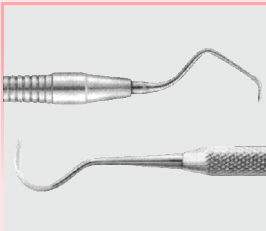
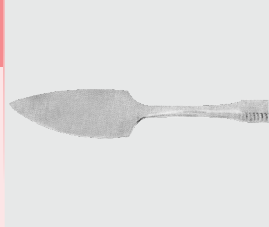
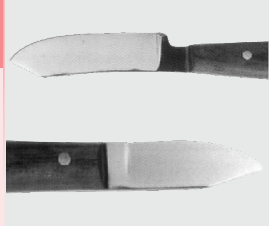
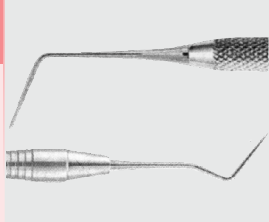
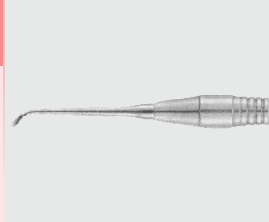
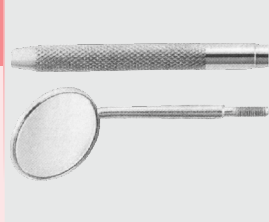
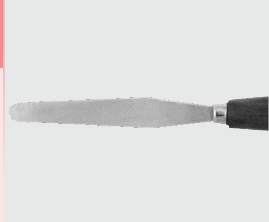
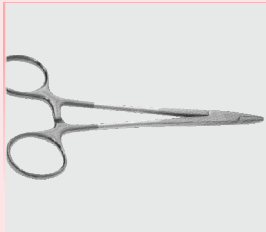

13

Needle Holders &
Saliva Ejectors

Page 94-100

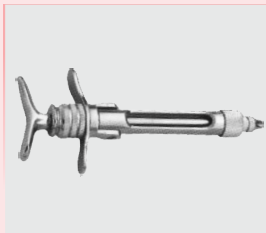

14

Syringes & Scissors

Page 101-109



15

Dental Tweezers

Page 110-114

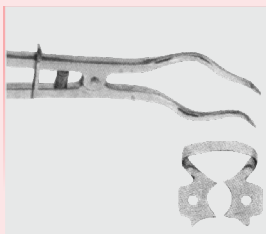

16

Rubber Dam Clamps

Page 115-117

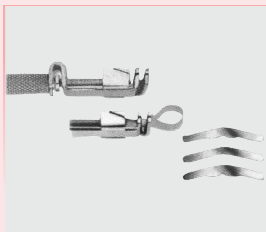

17

Matrix Retainers &
Matrix Bands

Page 118-119

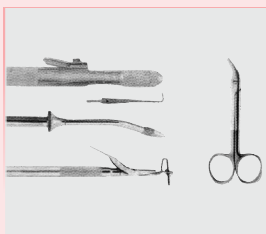





18

Crown Removers, Scissors,
Forceps, Amalgum Guns & Carriers

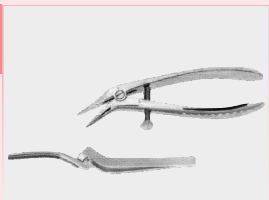
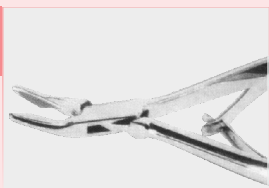
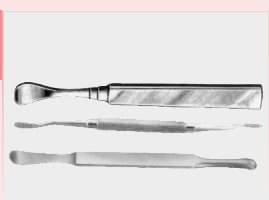
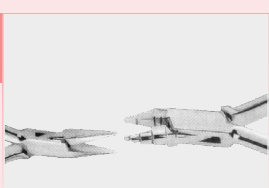
Page 120-122

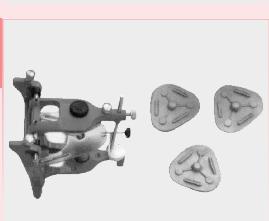
TABLE OF CONTENTS

Page 123	Copper Ring Removing Pliers & Paper Articulating Forceps	19	
Page 124-127	Rongeurs	20	
Page 128-129	Bone Elevators, Files & Chisels	21	
Page 130-151	Pliers For Orthodontics, Mouth Gags, Tongue Depressors Lip and Cheek Retractors and Implantology Instrumentns	22	
Page 152-155	Impression Trays	23	
Page 156-157	Articulators	24	
Page 158-160	Hollowares	25	



Page
1-31

- Extracting Forceps - English Pattern

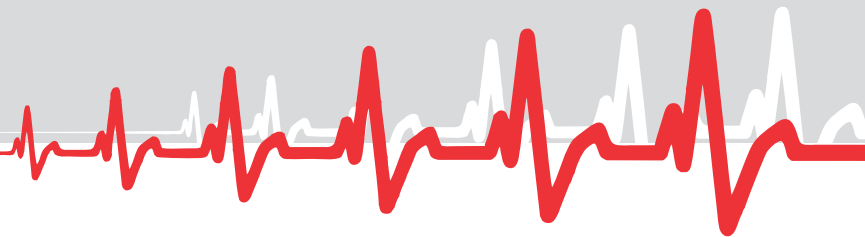



TS-1-5101
Fig 8
lower premolars



TS-1-5102
Fig 13
lower premolars

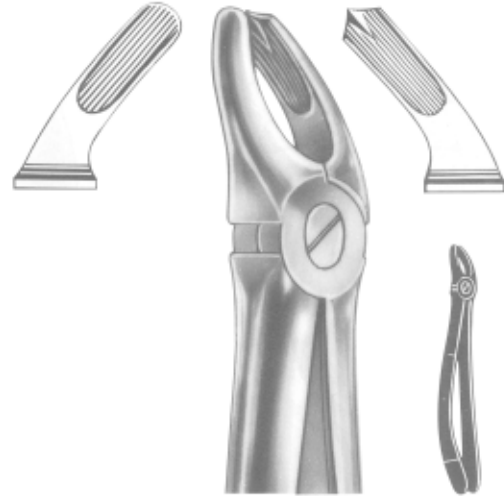

TS-1-5103
Fig 17
upper molars, right

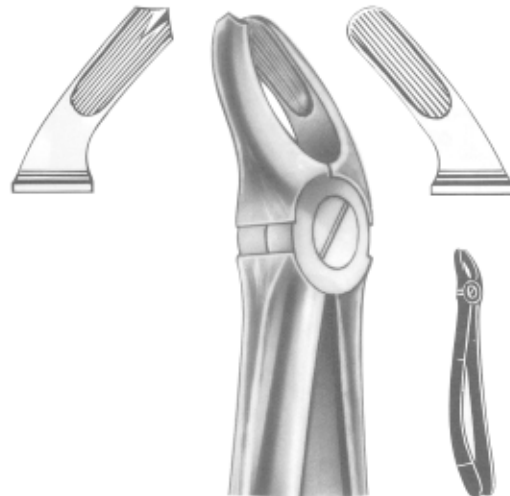

TS-1-5104
Fig 18
upper molars, left

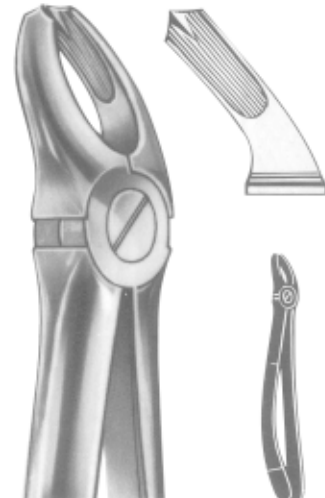

TS-1-5105
Fig 18 A
upper molars



TS-1-5106
Fig 19
upper wisdoms

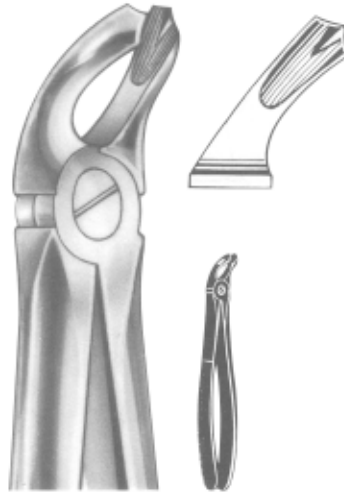

TS-1-5107
Fig 20
lower wisdoms

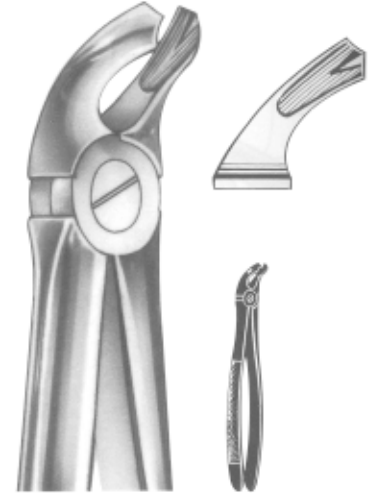

TS-1-5108
Fig 21
lower molars



TS-1-5109
Fig 22
lower molars



TS-1-5110
Fig 22 A
Albrecht
lower molars



TS-1-5111
Fig 33 A
lower roots

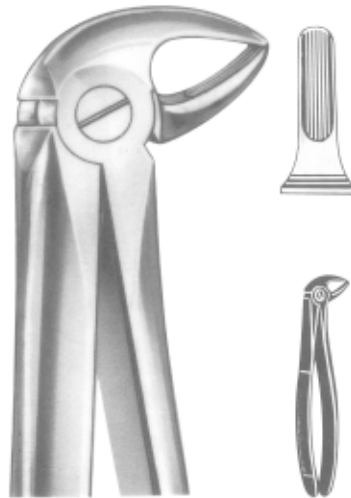

TS-1-5112
Fig 33 B
lower roots

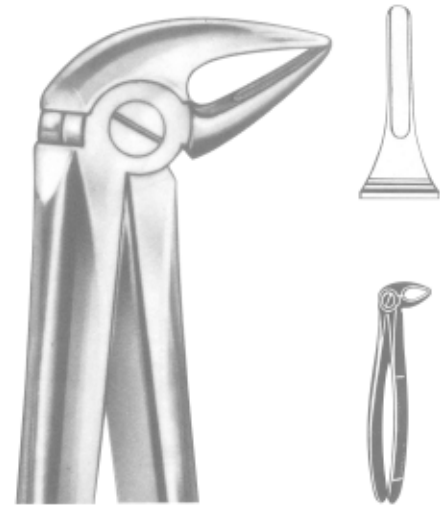

TS-1-5113
Fig 33 L
lower roots



TS-1-5114
Fig 33 L
lower roots



TS-1-5115
Fig 33 S
lower roots, for children



Extracting Forceps - English Pattern



TS-1-5116
Fig 44
upper roots

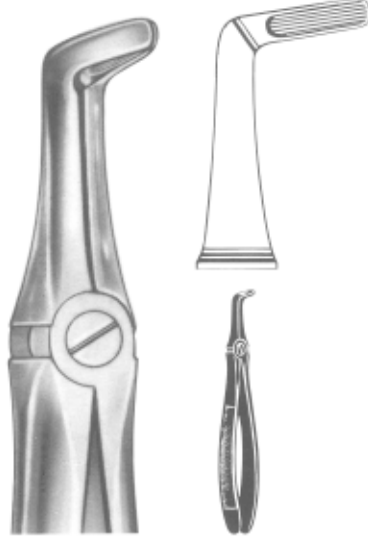

TS-1-5117
Fig 45
lower roots

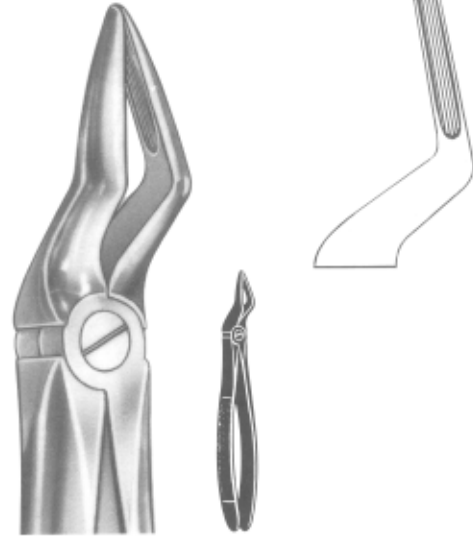

TS-1-5118
Fig 12
upper roots

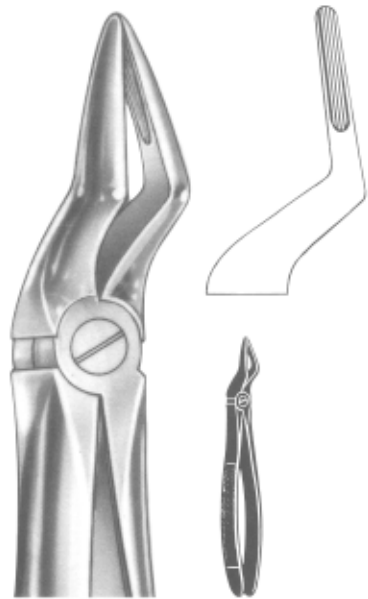

TS-1-5119
Fig 51 A
upper roots

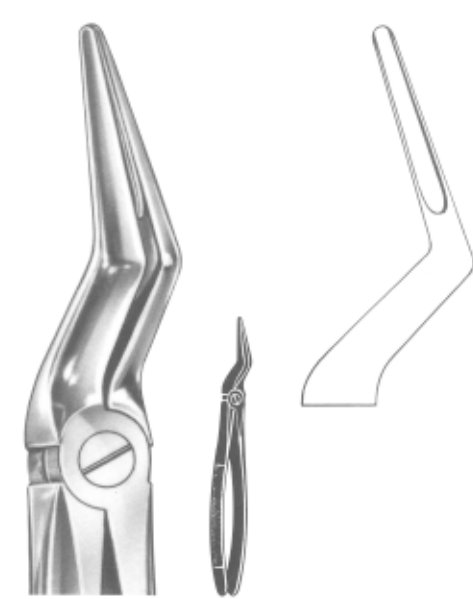

TS-1-5120
Fig 51 L
upper roots



Relax
TS-1-5121
Fig 51
upper roots



Relax
TS-1-5122
Fig 51 A
upper roots



Relax
TS-1-5123
Fig 51 L
upper roots



Relax
TS-1-5124
Fig 67
upper wisdoms



Relax
TS-1-5125
Fig 67 A
upper wisdoms



Extracting Forceps For Children - English Pattern



TS-1-5126
Fig 37
Upper incisors



WITH SERRATED
TIPS

TS-1-5127
Fig 39
Upper molars



WITH SERRATED
TIPS

TS-1-5128
Fig 39 R
Upper molars, right



WITH SERRATED
TIPS

TS-1-5129
Fig 39 L
Upper molars, left



WITH SERRATED
TIPS

TS-1-5130
Fig 515
Upper roots



Klein
TS-1-5132
Fig 137
upper incisors



Klein
TS-1-5131
Fig 6
lower molars



Klein
TS-1-5133
Fig 5
lower incisors

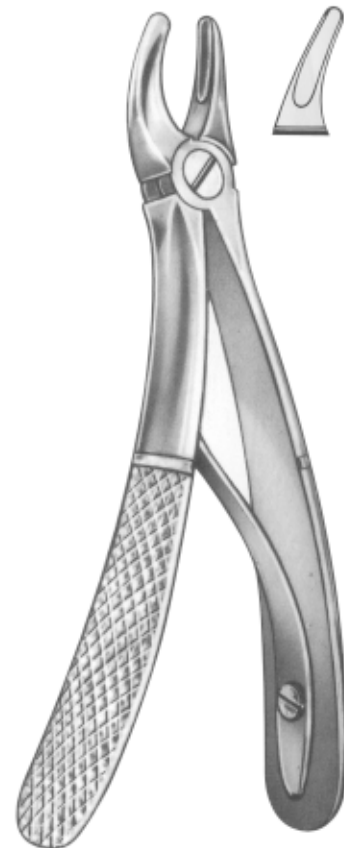

Klein
TS-1-5134
Fig 139
upper premolars



WITH SERRATED TIPS

TS-1-5135
Fig 43 A
Fractured or decayed
upper teeth

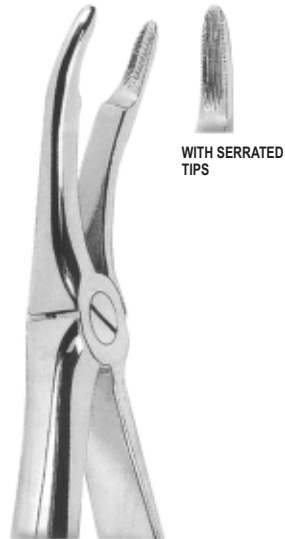

WITH SERRATED TIPS

TS-1-5136
Fig 44
Upper roots



WITH SERRATED TIPS

TS-1-5137
Fig 45
Lower roots

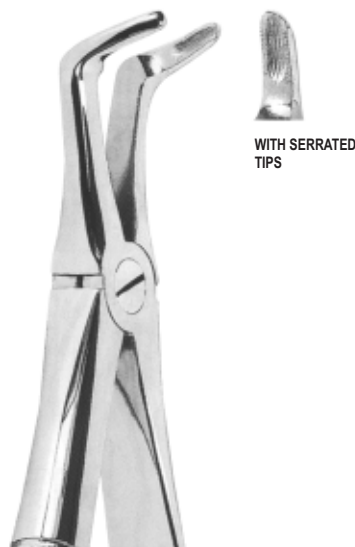

WITH SERRATED TIPS

TS-1-5138
Fig 46
Lower roots



WITH SERRATED TIPS

TS-1-5139
Fig 46 L
Lower roots



WITH SERRATED
TIPS

TS-1-5140
Fig 48
Upper roots



WITH SERRATED
TIPS

TS-1-5141
Fig 51
Upper roots



WITH SERRATED
TIPS

TS-1-5142
Fig 49
Upper roots



WITH SERRATED
TIPS

TS-1-5143
Fig 51 L
Upper roots



WITH SERRATED
TIPS

TS-1-5144
Fig 51 A
Upper roots



TS-1-5145
Fig 51 LX
Upper roots



1046
Fig 52
Upper roots and
canines



TS-1-5147
Fig 54
For separating
upper molars



TS-1-5148
Fig 55
For separating
upper molars



TS-1-5149
Fig 56
For separating
lower molars

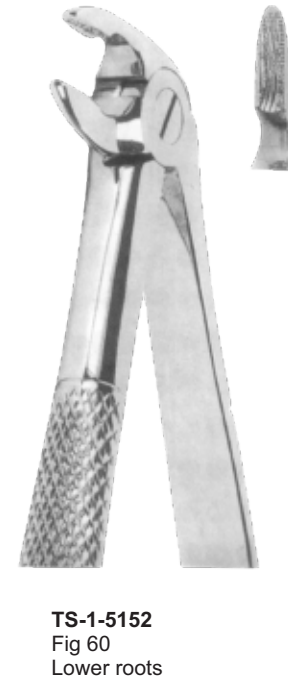

Extracting Forceps - English Pattern



WITH SERRATED TIPS

TS-1-5155
Fig 66 L
Upper molars, left



WITH SERRATED TIPS

TS-1-5156
Fig 66 R
Upper molars, right



WITH SERRATED TIPS

TS-1-5157
Fig 67
Upper third molars



WITH SERRATED TIPS

TS-1-5158
Fig 67 A
Upper third molars



WITH SERRATED TIPS

TS-1-5159
Fig 68
Lower roots



TS-1-5160
Fig 67½ L
Upper third molars, left



WITH SERRATED TIPS



TS-1-5161
Fig 67½ R
Upper third molars, right



WITH SERRATED TIPS



TS-1-5162
Fig 73
Lower molars



WITH SERRATED TIPS



TS-1-5163
Fig 74
Lower roots



WITH SERRATED TIPS



TS-1-5164
Fig 74 M
Lower roots



WITH SERRATED TIPS



WITH SERRATED TIPS

TS-1-515
Fig 74 N
Lower roots



WITH SERRATED TIPS

TS-1-5166
Fig 75
Lower canines and premolars

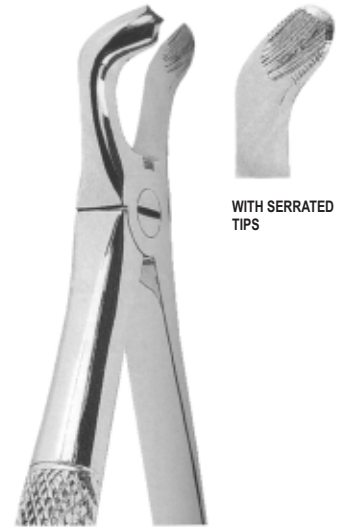

WITH SERRATED TIPS

TS-1-5167
Fig 79
Lower third molars



WITH SERRATED TIPS

TS-1-5168
Fig 79 A
Lower third molars

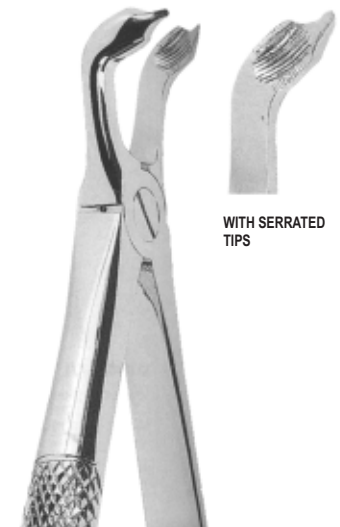

WITH SERRATED TIPS

TS-1-5169
Fig 79 C
Lower third molars

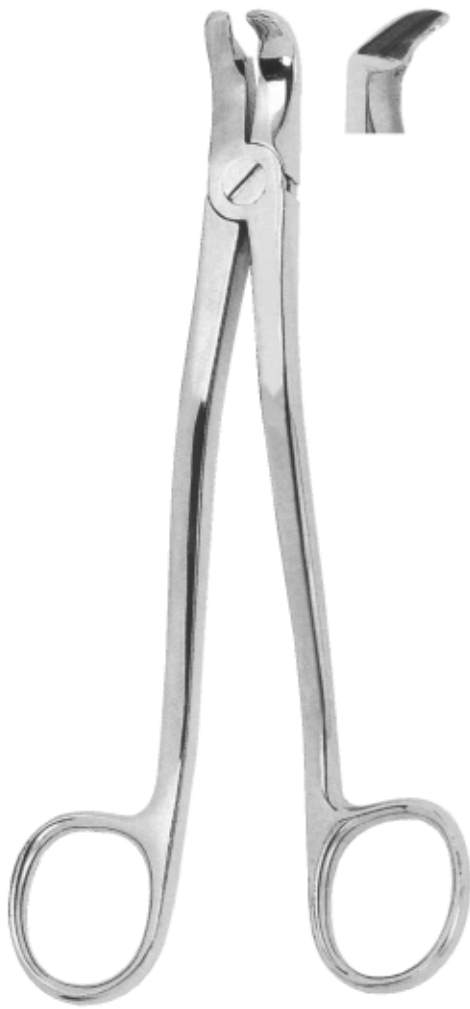

TS-1-5170
Fig 86 W
Lower third molars



TS-1-5171
Fig 86 1/2 L
Lower third molars, left



TS-1-5172
Fig 86 1/2 R
Lower third molars, right



TS-1-5173
Fig 86 C
Lower molars



TS-1-5174
Fig 87
Lower decayed molars
or broken-down crowns



WITH SERRATED
TIPS

TS-1-5175
Fig 89
Upper molars, right



WITH SERRATED
TIPS

TS-1-5176
Fig 90
Upper molars, left



WITH SERRATED
TIPS

TS-1-5177
Fig 99
Broken-down lower molars

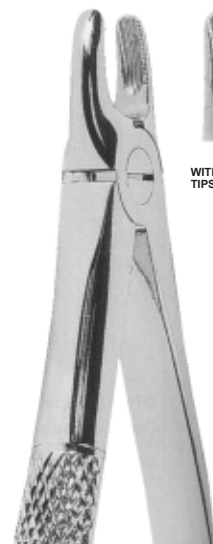

WITH SERRATED
TIPS

TS-1-5178
Fig 107
Upper canines



WITH SERRATED TIPS

TS-1-5179
Fig 121
Upper third molars



WITH SERRATED TIPS

TS-1-5180
Fig 145
Lower roots



WITH SERRATED TIPS

TS-1-5181
Fig 151½
Upper roots



WITH SERRATED TIPS

TS-1-5182
Fig 166
Universal extracting forceps for upper teeth, in particular molars and premolars



WITH SERRATED TIPS

TS-1-5183
Fig 167
Universal extracting forceps for lower teeth, in particular molars and premolars



Extracting Forceps - English Pattern



WITH SERRATED TIPS

TS-1-5184
Fig 168
Upper canines



WITH SERRATED TIPS

TS-1-5185
Fig 169
Lower canines

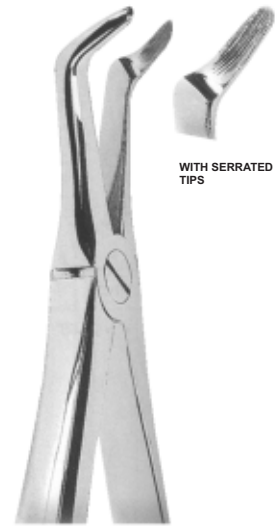

WITH SERRATED TIPS

TS-1-5186
Fig 346
Lower roots



WITH SERRATED TIPS

TS-1-5187
Fig 349
Upper roots



WITH SERRATED TIPS

TS-1-5188
Fig 359
Lower roots



TS-1-5189
Fig 1
Universal extracting forcep for upper incisors and canines



WITH SERRATED TIPS

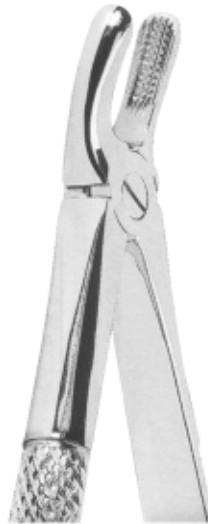

TS-1-5190
Fig 2
Upper molars



WITH SERRATED TIPS

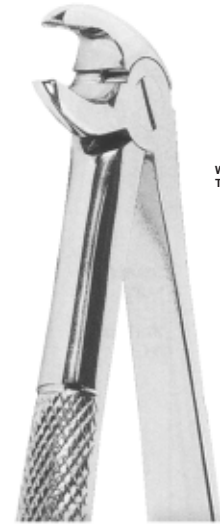

TS-1-5191
Fig 3
Lower incisors, premolar and roots



WITH SERRATED TIPS



TS-1-5192
Fig 4
Lower molars



WITH SERRATED TIPS



Extracting Forceps With Anatomically Shyped Handle



TS-1-5193
Fig 1
Upper incisors
and canines



TS-1-5194
Fig 2
Upper incisors
and canines

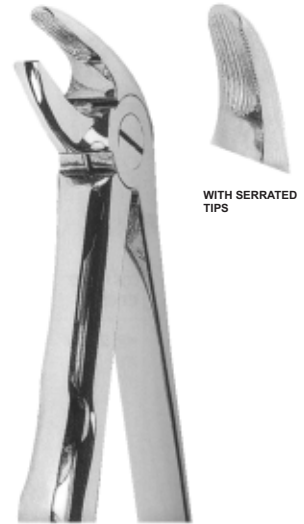

TS-1-5195
Fig 4
Lower incisors
and canines



TS-1-5196
Fig 7
Upper premolars



TS-1-5197
Fig 13
Lower premolars



TS-1-5198
Fig 17
Upper molars, right

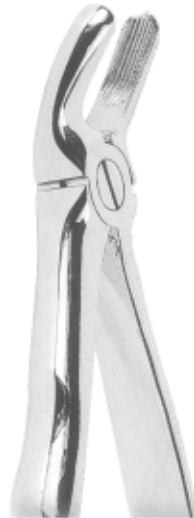

TS-1-5199
Fig 18
Upper molars, left



WITH SERRATED TIPS

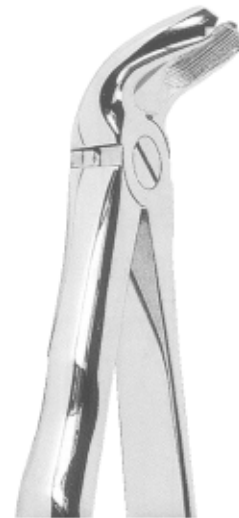

TS-1-5200
Fig 21
Lower molars



WITH SERRATED TIPS



TS-1-5201
Fig 22
Lower molars



WITH SERRATED TIPS



TS-1-5202
Fig 33
Lower roots



WITH SERRATED TIPS



Extracting Forceps With Anatomically Shaped Handle



TS-1-5203
Fig 45
Lower roots



WITH SERRATED TIPS



WITH SERRATED TIPS

TS-1-5204
Fig 51 A
Upper roots



WITH SERRATED TIPS

TS-1-5205
Fig 67 A
Upper third molars



WITH SERRATED TIPS

TS-1-5206
Fig 74
Lower roots

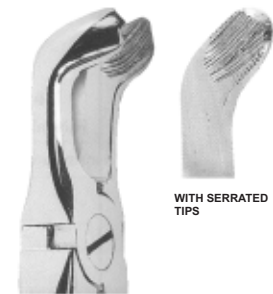

WITH SERRATED TIPS

TS-1-5207
Fig 79
Lower third molars



WITH SERRATED TIPS

TS-1-5208
Fig 86 C
Lower molars



WITH SERRATED TIPS

TS-1-5209
Fig 359
Lower roots



TS-1-5210
Fig 89
Upper molars, right



WITH SERRATED TIPS



TS-1-5211
Fig 90
Upper molars, left



WITH SERRATED TIPS



TS-1-5212
Fig 145
Lower roots



WITH SERRATED TIPS



TS-1-5213
Fig 151 1/2
Upper roots



WITH SERRATED TIPS



TS-1-5214
Fig 349
Upper roots



WITH SERRATED TIPS

Extracting Forceps - American Pattern



TS-1-5215
Fig 5
Lower third molars



TS-1-5216
Fig 6
Separating forceps



TS-1-5217
Fig 105
Upper molars



TS-1-5218
Fig 16
Lower molars



TS-1-5219
Fig 17
Lower molars



TS-1-5220
Fig 18 L
Upper molars, left



TS-1-5221
Fig 18 R
Upper molars, right



TS-1-5222
Fig 23
Lower molars



TS-1-5223
Fig 53 R
Upper molars, right



TS-1-5224
Fig 53 L
Upper molars, left



Extracting Forceps - American Pattern



TS-1-5225
Fig 65
Upper incisors and roots



TS-1-5226
Fig 69
Upper and lower roots



TS-1-5227
Fig 88 R
Upper molars, right



TS-1-5228
Fig 88 L
Upper molars, left



TS-1-5229
Fig 101
Deciduous teeth



TS-1-5230
Fig 150
Upper incisors, premolars, roots

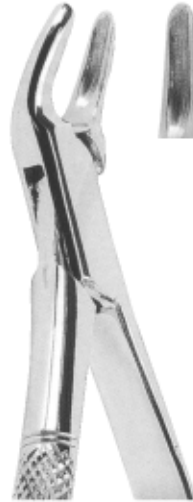

TS-1-5231
Fig 150 S
Upper teeth (for children)



TS-1-5232
Fig 151
Upper incisors, premolars, roots



TS-1-5233
Fig 151S
Lower teeth (for children)

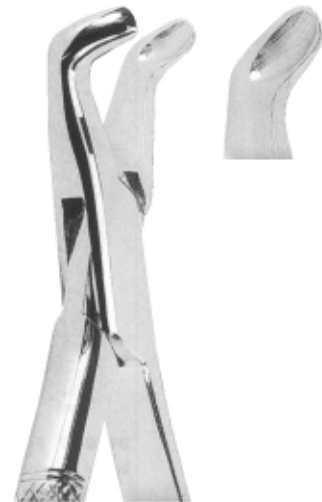

TS-1-5234
Fig 222
Lower third molars



Extracting Forceps - American Pattern



TS-1-5235
Fig 1
upper incisors and bicuspid

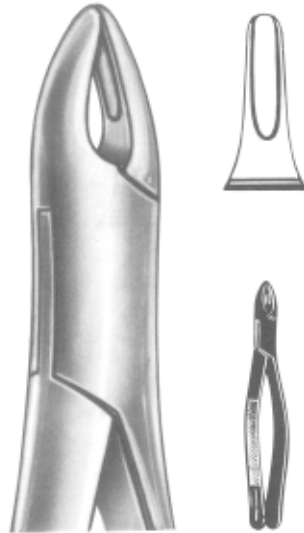

TS-1-5236
Fig 1 B
upper roots, anterior

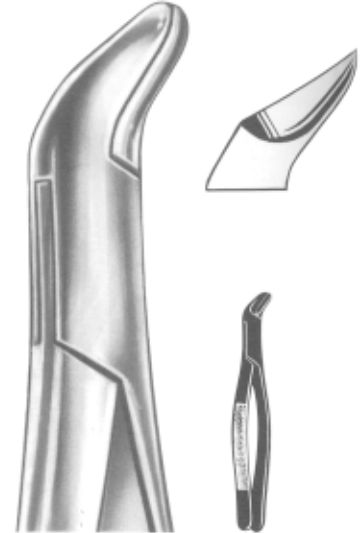

Physick
TS-1-5237
Fig 5
lower wisdoms

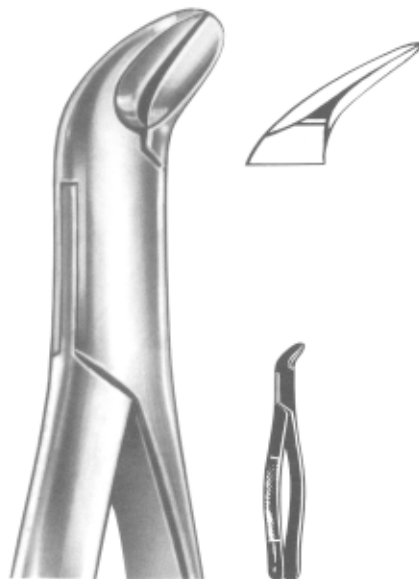

TS-1-5238
Fig 6
lower molars, splitting forceps



TS-1-5239
Fig 10 H
upper molars





TS-1-5240
Fig 135
Lower premolars



WITH SERRATED
TIPS



TS-1-5241
Fig 225
Lower molars



TS-1-5242
Fig 305
Upper incisors
and roots



TS-1-5243
Fig 33 S
Lower roots



WITH SERRATED
TIPS



TS-1-5244
Fig 38
Lower incisors
and canines



WITH SERRATED
TIPS



Extracting Forceps For Children - Klein Pattern

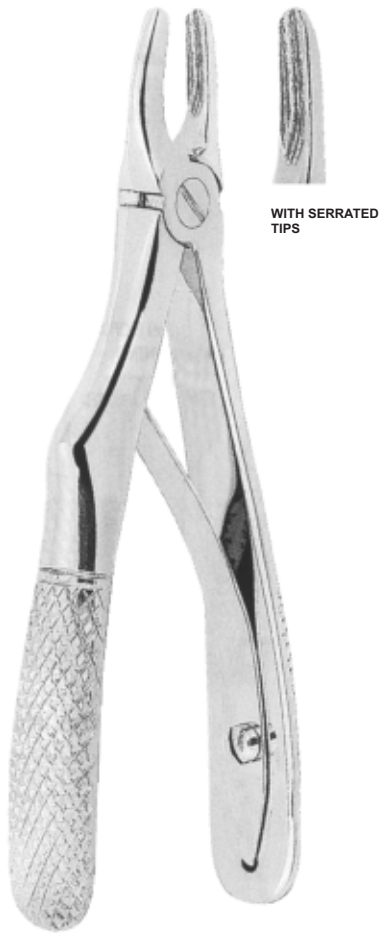

TS-1-5245
Fig 1
Upper incisors



WITH SERRATED TIPS



TS-1-5246
Fig 2
Upper permolars



WITH SERRATED TIPS



TS-1-5247
Fig 3
Upper molars



WITH SERRATED TIPS



TS-1-5248
Fig 4
Upper roots



WITH SERRATED TIPS



TS-1-5249
Fig 5
Lower incisors



WITH SERRATED TIPS



TS-1-5250
Fig 6
Lower molars



WITH SERRATED TIPS



TS-1-5251
Fig 7
Lower roots



WITH SERRATED TIPS



TS-1-5252
 Fig 1
 Lower roots



WITH SERRATED
 TIPS



TS-1-5253
 Fig 2
 Upper roots



WITH SERRATED
 TIPS



TS-1-5255
 Fig 2
 Roots fragments



TS-1-5254
 Fig 1
 Roots fragments



Page
32-50

- Root Elevators





lower jaw, left side

lower jaw, right side

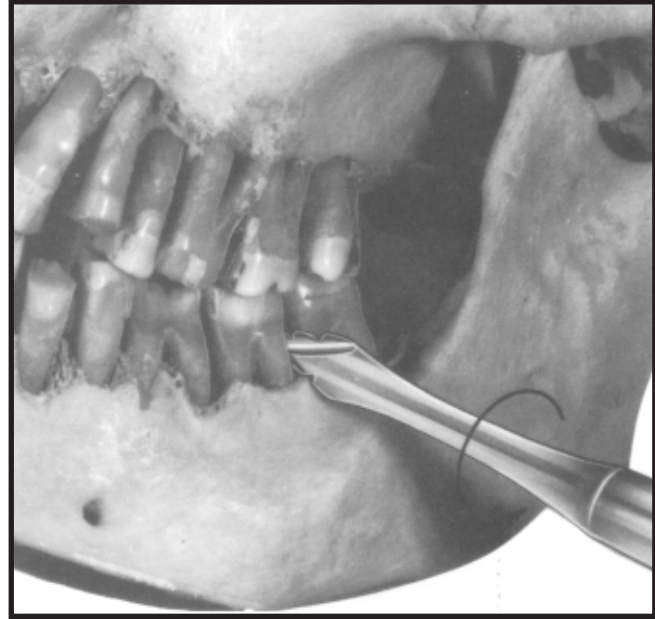

TS-2-5101



TS-2-5102

Root elevator, spiral-shaped, for extremely facilitated extraction of the molars in the lower jaw. The slender, conical points allow deep penetration between tooth and gum. Owing to the hook-shaped working parts, slipping of the elevator is avoided.



Root Elevators



Bein

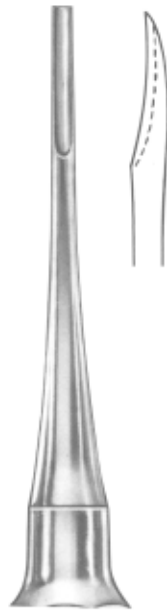

**Bein
TS-2-5103
Fig 1**



**Bein
TS-2-5104
Fig 2**

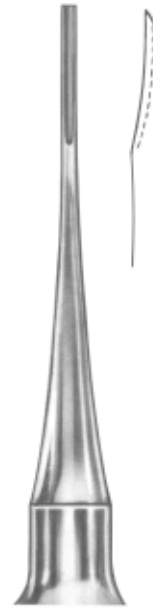

**Bein
TS-2-5105
Fig 0**



**Bein
TS-2-5106
Fig 3**

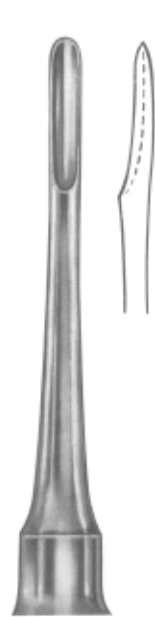

**Bein
TS-2-5107
Fig 4**

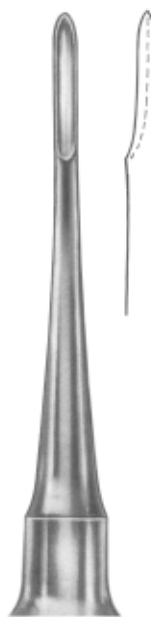

**Bein
TS-2-5108
Fig 5**



**Bein
TS-2-5109
Fig 6**



Seldin



Seldin
TS-2-5110
Fig 1L



Seldin
TS-2-5111
Fig 1R



Seldin
TS-2-5112
Fig 2



Seldin
TS-2-5113
Fig 3



Seldin
TS-2-5114
Fig 4L



Seldin
TS-2-5115
Fig 4R



Root Elevators



**Cryer
TS-2-5116
Fig 3**



**Cryer
TS-2-5117
Fig 4**



**Cryer
TS-2-5118
Fig 12**



**Cryer
TS-2-5119
Fig 27**



**Cryer
TS-2-5120
Fig 28**



**Cryer
TS-2-5121
Fig 27 S**



**Cryer
TS-2-5122
Fig 28 S**



Apical



Apical
TS-2-5123
Fig 1



Apical
TS-2-5124
Fig 2



Apical
TS-2-5125
Fig 3



Apical
TS-2-5126
Fig 4



Root Elevators



Cryer



**Cryer
TS-2-5127
Fig 1**



**Cryer
TS-2-5128
Fig 2**



Coupland



**Coupland
TS-2-5129
Fig 1**



**Coupland
TS-2-5130
Fig 2**



**Coupland
TS-2-5131
Fig 3**



TS-2-5132
Fig 1

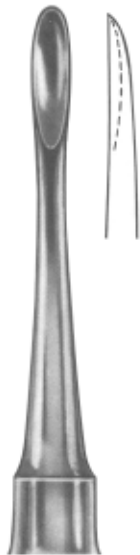

TS-2-5133
Fig 2

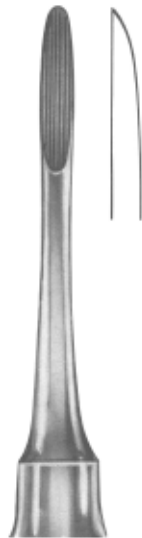

TS-2-5134
Fig 3



Flohr
TS-2-5135
Fig 1



Flohr
TS-2-5136
Fig 2



Flohr
TS-2-5137
Fig 3



Root Elevators



Kopp
TS-2-5138
Fig 1



Kopp
TS-2-5139
Fig 2



Kopp
TS-2-5144
Fig 1



Kopp
TS-2-5145
Fig 2



Kopp



Kopp
TS-2-5140
Fig 3



Kopp
TS-2-5141
Fig 4



Kopp



Kopp
TS-2-5146
Fig 3



Kopp
TS-2-5147
Fig 4



Kopp
TS-2-5142
Fig 5



Kopp
TS-2-5143
Fig 6



Hylin



Hylin
TS-2-5148
Fig 1



Hylin
TS-2-5149
Fig 2



Bein

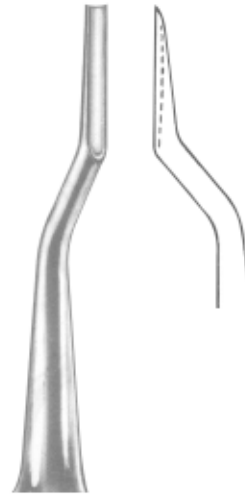

Bein
TS-2-5150
Fig 1

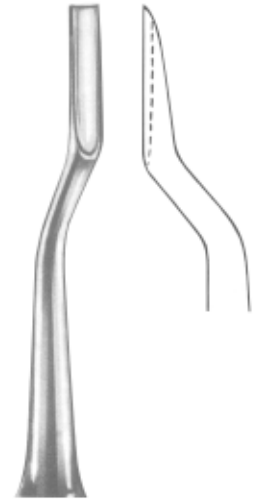

Bein
TS-2-5151
Fig 2



Bein
TS-2-5152
Fig 3



Bein
TS-2-5153
Fig 4



Root Elevators



**Warwick-James
TS-2-5154
Fig 1**



**Warwick-James
TS-2-5155
Fig 2**



**Warwick-James
TS-2-5156
Fig 3**



**London Hospital
TS-2-5157
Fig 1**



**London Hospital
TS-2-5158
Fig 2**



**London Hospital
TS-2-5159
Fig 3**



**Ott
TS-2-5160**

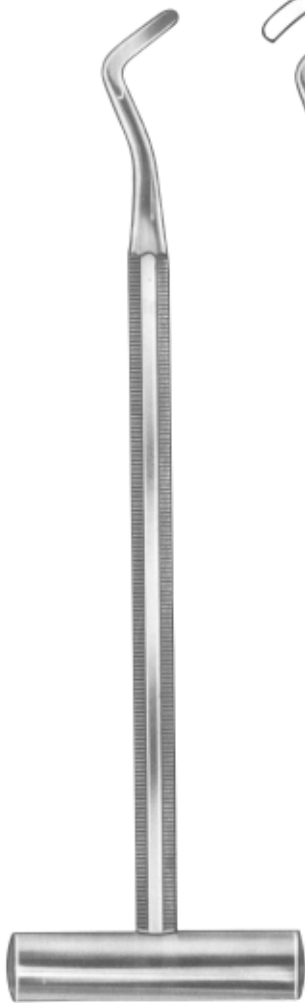

Pott



Pott
TS-2-5162
Fig 1



Pott
TS-2-5163
Fig 2

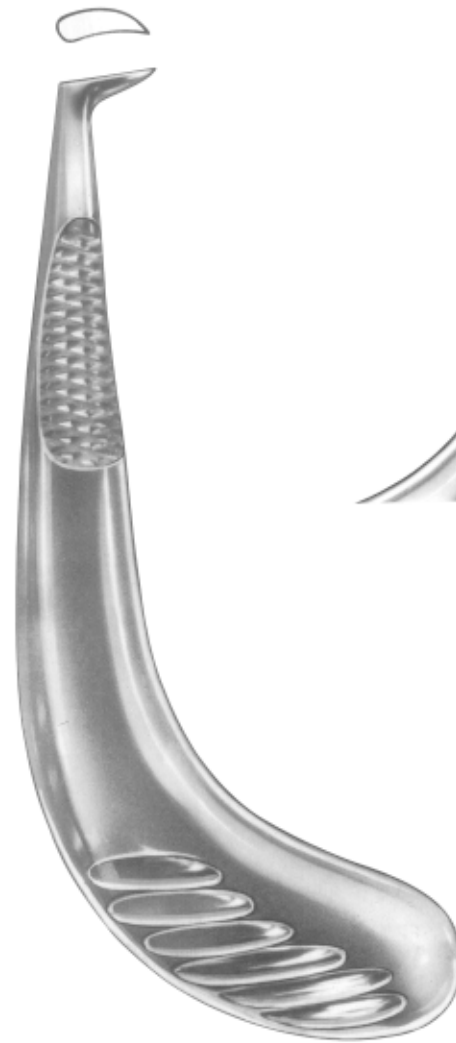

TS-2-5164
Fig 1

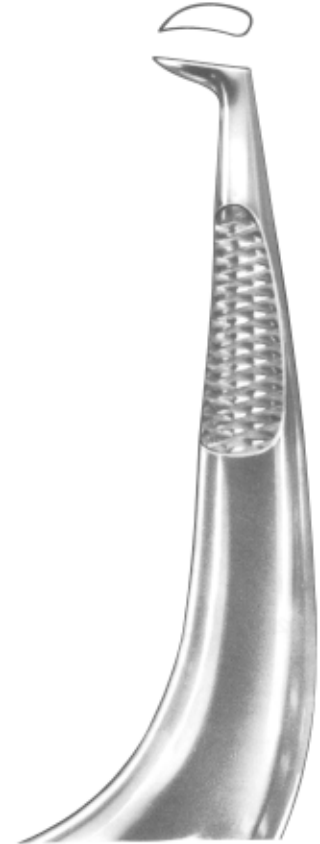

TS-2-5165
Fig 2



Root Elevators

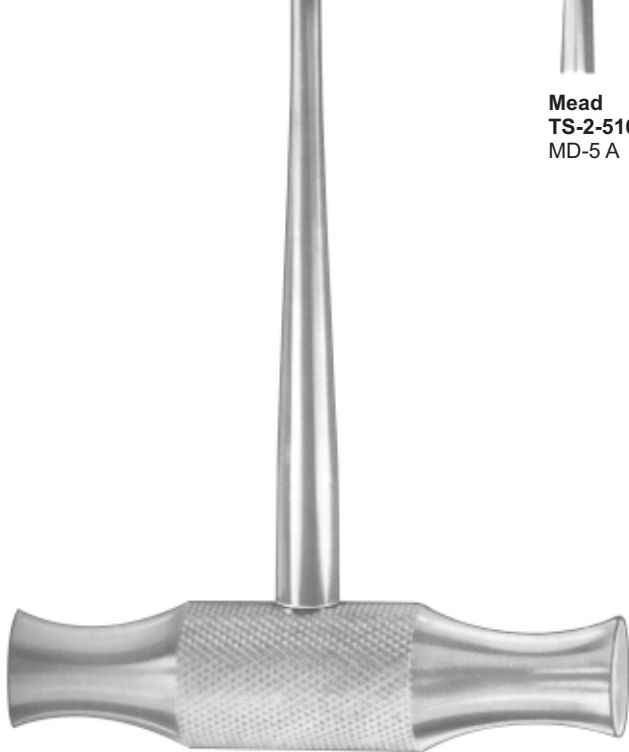

**Mead
TS-2-5166
MD 1**



**Mead
TS-2-5167
MD-5 A**



**Mead
TS-2-5168
MD-6 A**



**Mead
TS-2-5169
MD-7 A**



**Mead
TS-2-5170
MD-8**

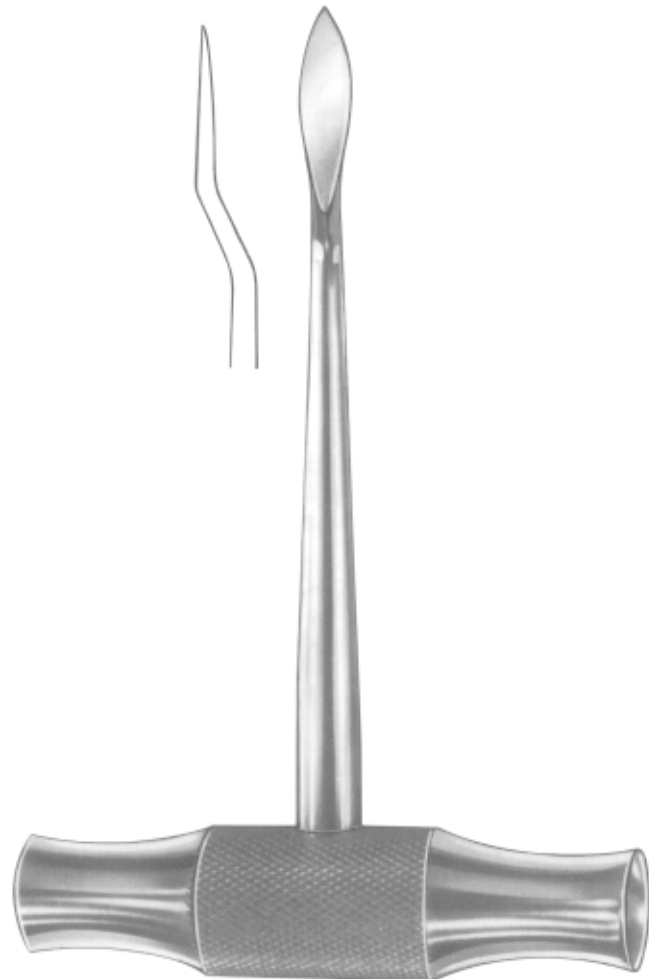

**Lecluse
TS-2-5171**



Chompret
TS-2-5172
Fig 1



Chompret
TS-2-5173
Fig 2



Chompret
TS-2-5174
Fig 3



Chompret
TS-2-5175
Fig 4



Apical
TS-2-5176



Root Elevators Root Tip Elevators



TS-2-5177
Fig 1



TS-2-5178
Fig 2



TS-2-5179
Fig 3



Heidbrink
TS-2-5180
Fig 1



Heidbrink
TS-2-5181
Fig 2



Heidbrink
TS-2-5182
Fig 3



Winter
TS-2-5183
Fig 1L



Winter
TS-2-5184
Fig 1R



Winter
TS-2-5185
Fig 2L



Winter
TS-2-5186
Fig 2R

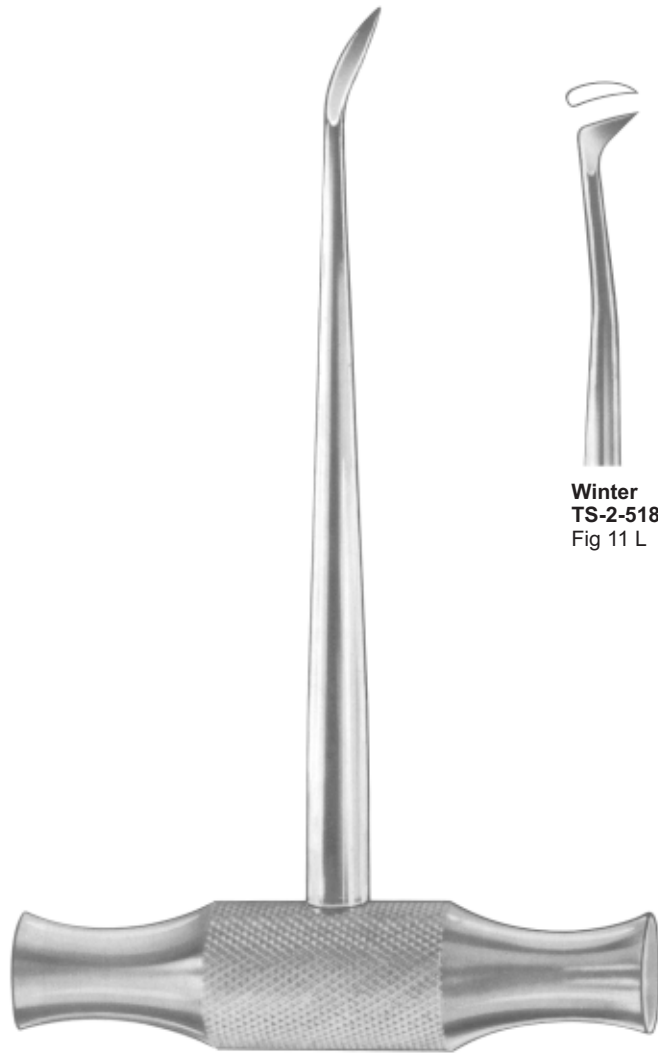

Winter



Winter
TS-2-5187
Fig 11 L



Winter
TS-2-5188
Fig 11 R



Winter
TS-2-5189
Fig 12 L



Winter
TS-2-5190
Fig 12 R



Winter
TS-2-5191
Fig 14 L



Winter
TS-2-5192
Fig 14 R



Root Elevators



**Barry
TS-2-5193
Fig 1**



**Barry
TS-2-5194
Fig 2**



**Barry
TS-2-5195
Fig 3**



**Barry
TS-2-5196
Fig 4**



Barry



**Barry
TS-2-5197
Fig 11**



**Barry
TS-2-5198
Fig 12**



**Barry
TS-2-5199
Fig 17**



**Barry
TS-2-5200
Fig 18**



Cryer
TS-2-5201
Fig 26



Seldin
TS-2-5202
Fig 27



Cryer
TS-2-5203
Fig 28



Cryer
TS-2-5204
Fig 29



Heidbrink
TS-2-5205
Fig 22



Heidbrink
TS-2-5206
Fig 23



TS-2-5207



Root Elevators



Kopp
TS-2-5208
Fig 31



Kopp
TS-2-5209
Fig 32



Kopp
TS-2-5210
Fig 33



Kopp
TS-2-5211
Fig 34



Kopp
TS-2-5212
Fig 35



Kopp
TS-2-5213
Fig 44



TS-2-5214



Heidbrink
TS-2-5215
Fig 10



Winter
TS-2-5216
Fig 11



Winter
TS-2-5217
Fig 12



Barry
TS-2-5218
Fig 17



Barry
TS-2-5219
Fig 18



TS-2-5220
Fig 20



TS-2-5221



Root Elevators according to Dr. Sader,
with interchangeable working tips



TS-2-5222

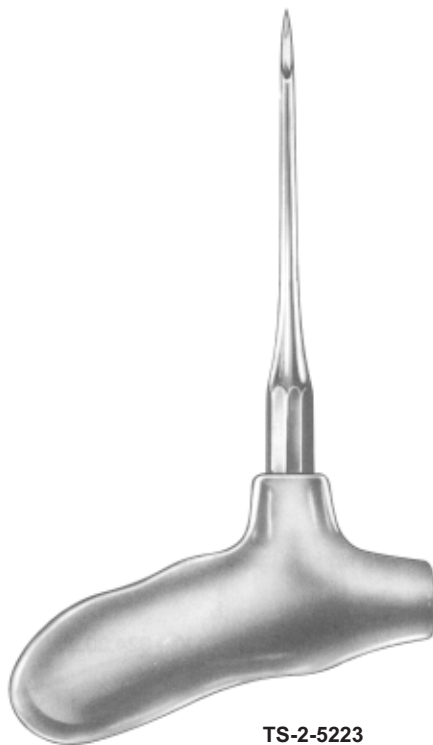

TS-2-5223



TS-2-5224



Page
51-55

- Filling Instruments

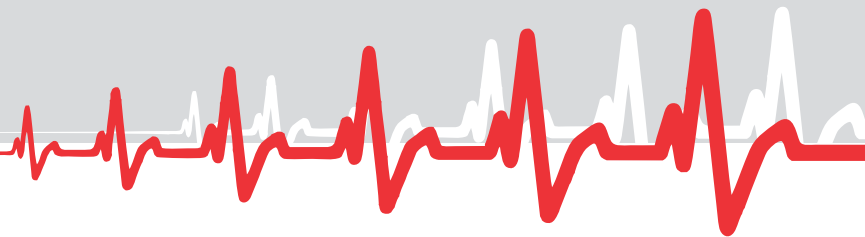



TS-2-5225
Williams

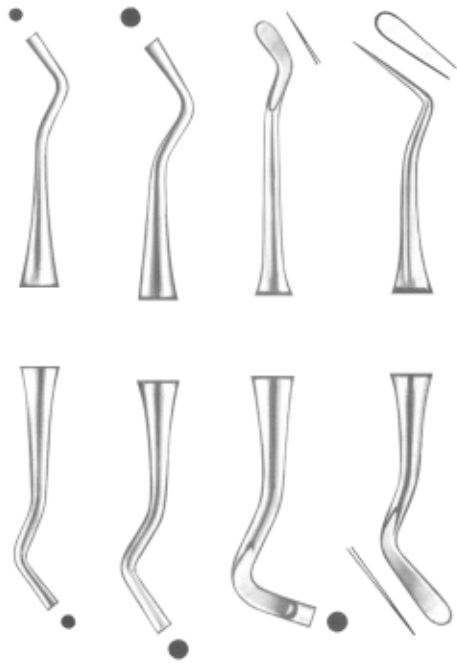

TS-2-5226 Williams
TS-2-5227 Williams
TS-2-5228 Williams
TS-2-5229 Williams

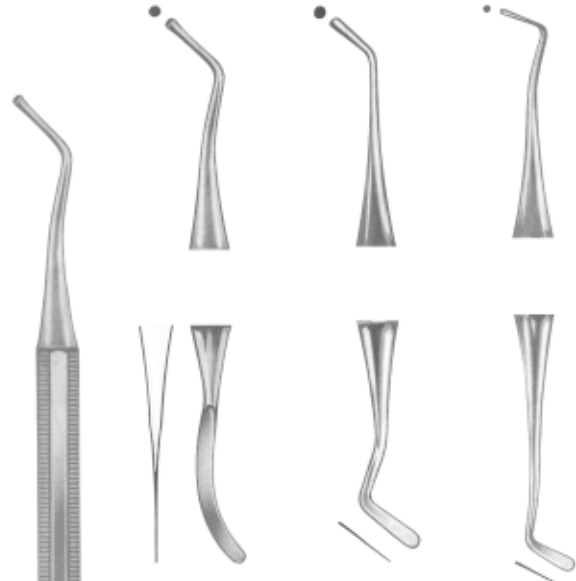

TS-2-5234
White

TS-2-5235
White

TS-2-5236
White

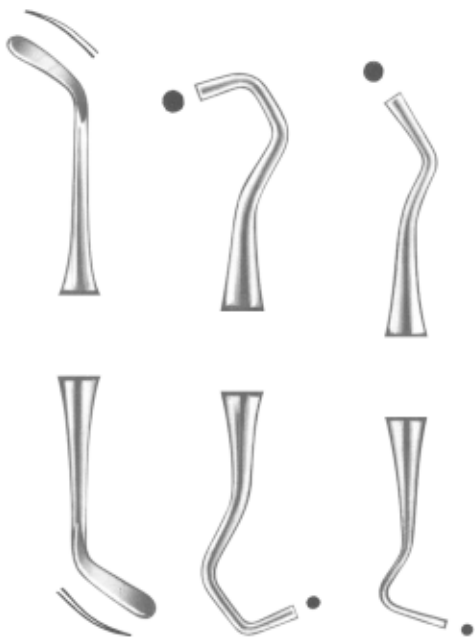

TS-2-5230
Williams

TS-2-5231
Williams

TS-2-5232
Williams

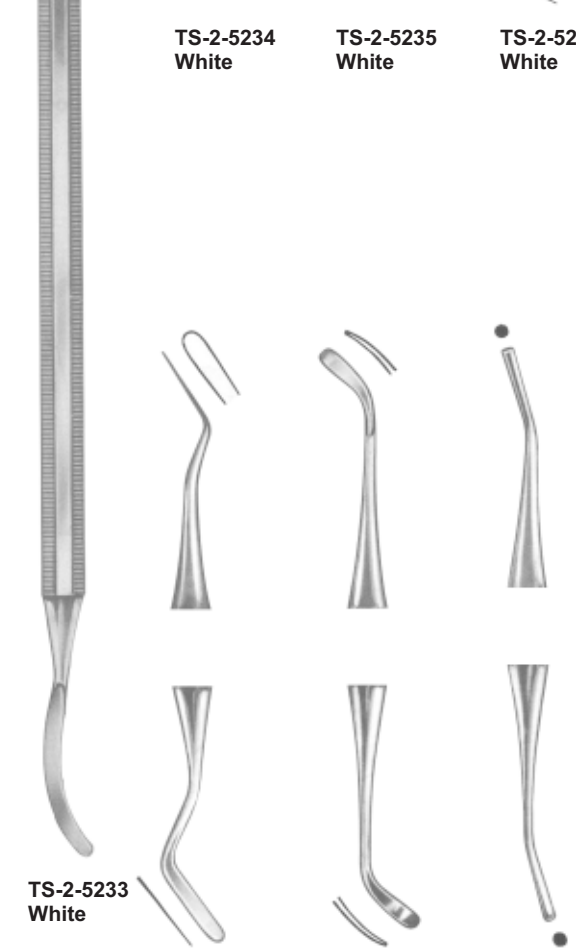

TS-2-5233
White

TS-2-5237
White

TS-2-5238
White

TS-2-5239
White

Filling Instruments

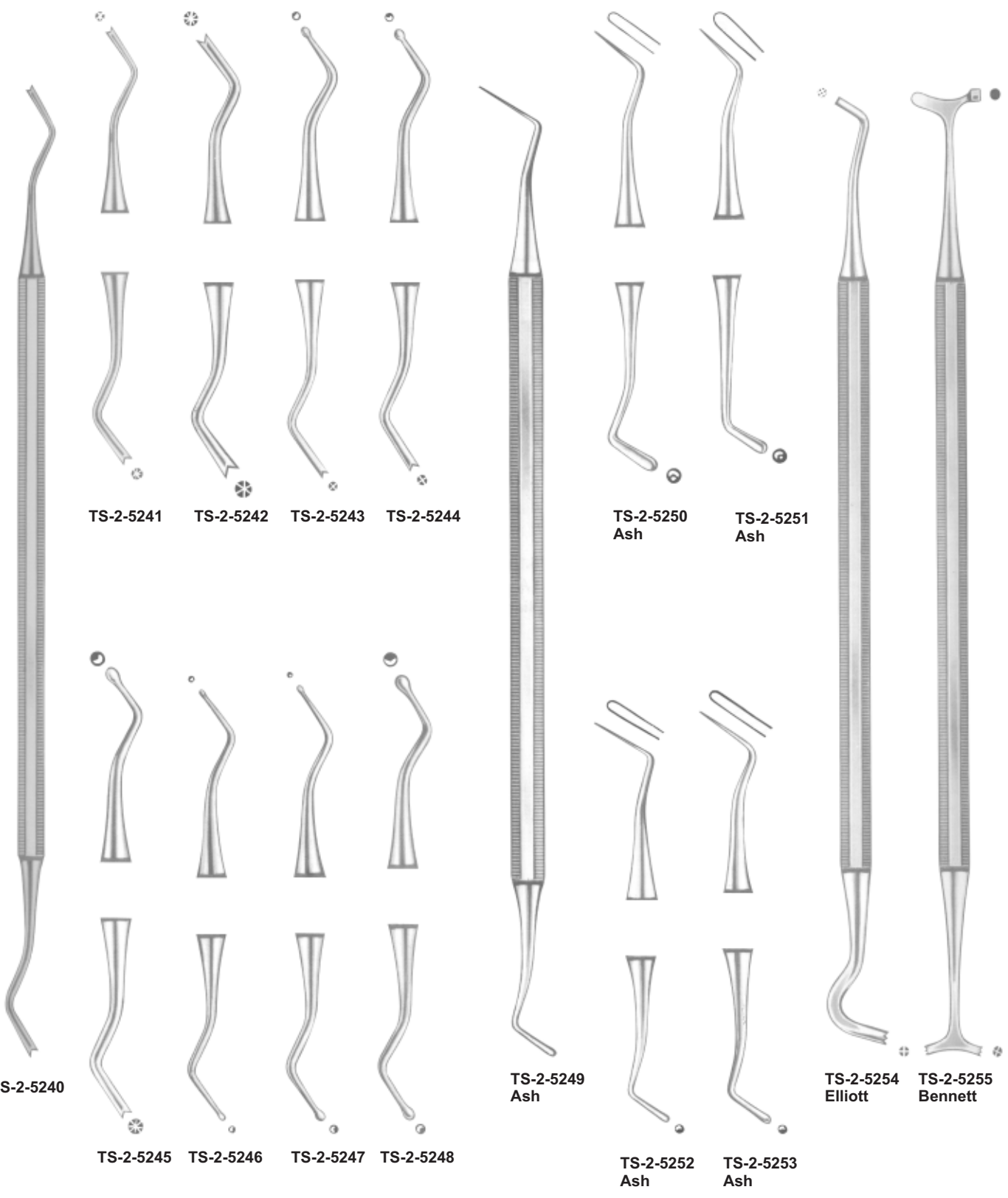

TS-2-5241 TS-2-5242 TS-2-5243 TS-2-5244

TS-2-5250 Ash TS-2-5251 Ash

TS-2-5240

TS-2-5249 Ash

TS-2-5254 Elliott TS-2-5255 Bennett

TS-2-5245 TS-2-5246 TS-2-5247 TS-2-5248

TS-2-5252 Ash TS-2-5253 Ash

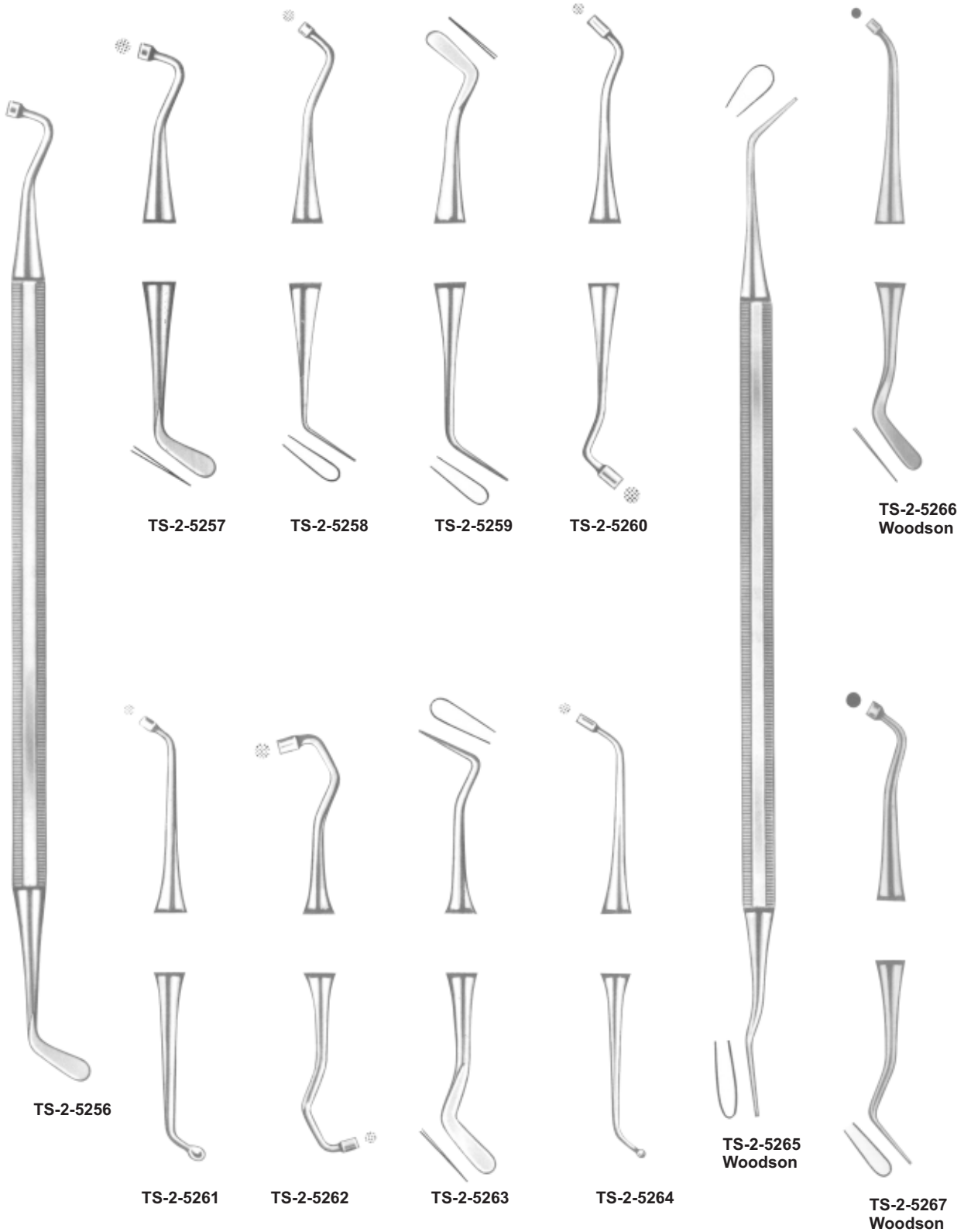

TS-2-5257

TS-2-5258

TS-2-5259

TS-2-5260

TS-2-5266
Woodson

TS-2-5256

TS-2-5261

TS-2-5262

TS-2-5263

TS-2-5264

TS-2-5265
Woodson

TS-2-5267
Woodson

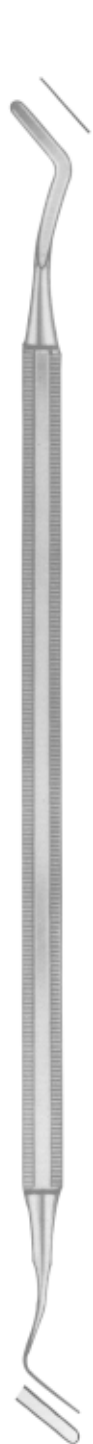

TS-2-5268
Heidemann
Fig 1



TS-2-5269
Heidemann
Fig 2



TS-2-5270
Heidemann
Fig 3

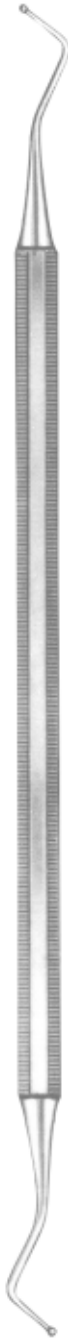

TS-2-5271



TS-2-5272
Fig 146



TS-2-5274
Fig 148



TS-2-5273
Fig 147



TS-2-5275
Fig 149

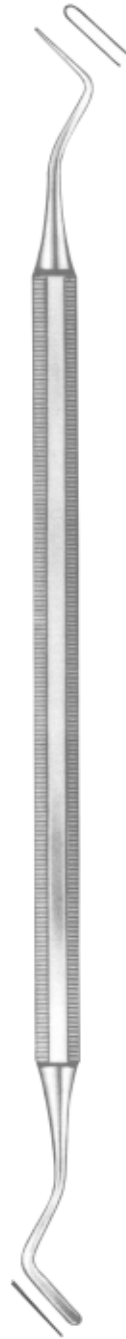

TS-2-5276
Fig 158



TS-2-5277
Fig 159

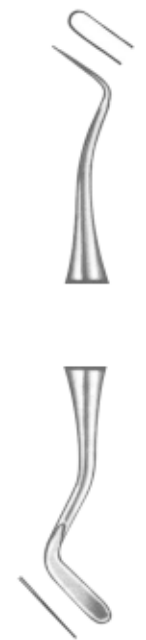

TS-2-5278
Woodson
Fig 160



TS-2-5279
Gracey



TS-2-5280
Gracey
Fig 1



TS-2-5281
Gracey
Fig 2



TS-2-5282
Gracey
Fig 3

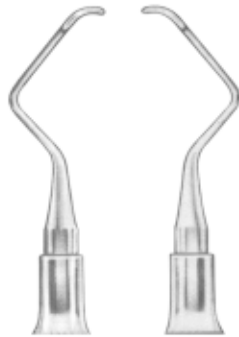

TS-2-5283
Gracey
Fig 4



TS-2-5284
Gracey
Fig 5

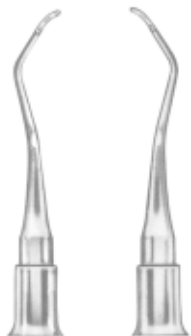

TS-2-5285
Gracey
Fig 6



TS-2-5286



TS-2-5287
Fig 18



TS-2-5288
Fig 19



TS-2-5289
Fig 20



TS-2-5290
Fig 22



TS-2-5291
Fig 23



TS-2-5292
Fig 25



TS-2-5293
Fig 26



TS-2-5294
Fig 27



Page
56–59

- Dental Probes

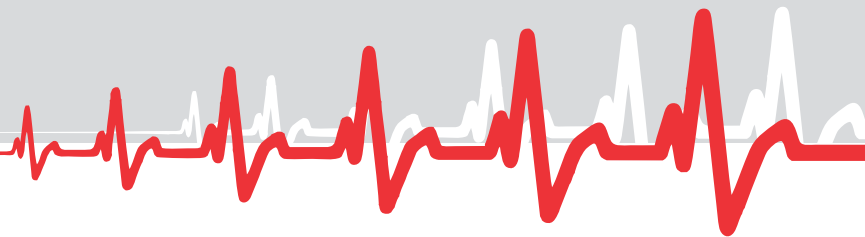

Dental Probes



With Point Set In



TS-2-5295



TS-2-5296



TS-2-5297



TS-2-5298



TS-2-5299



TS-2-5300



TS-2-5301



TS-2-5302



TS-2-5303



TS-2-5304



TS-2-5305



TS-2-5306



TS-2-5307
Woodson



Polishing Instruments

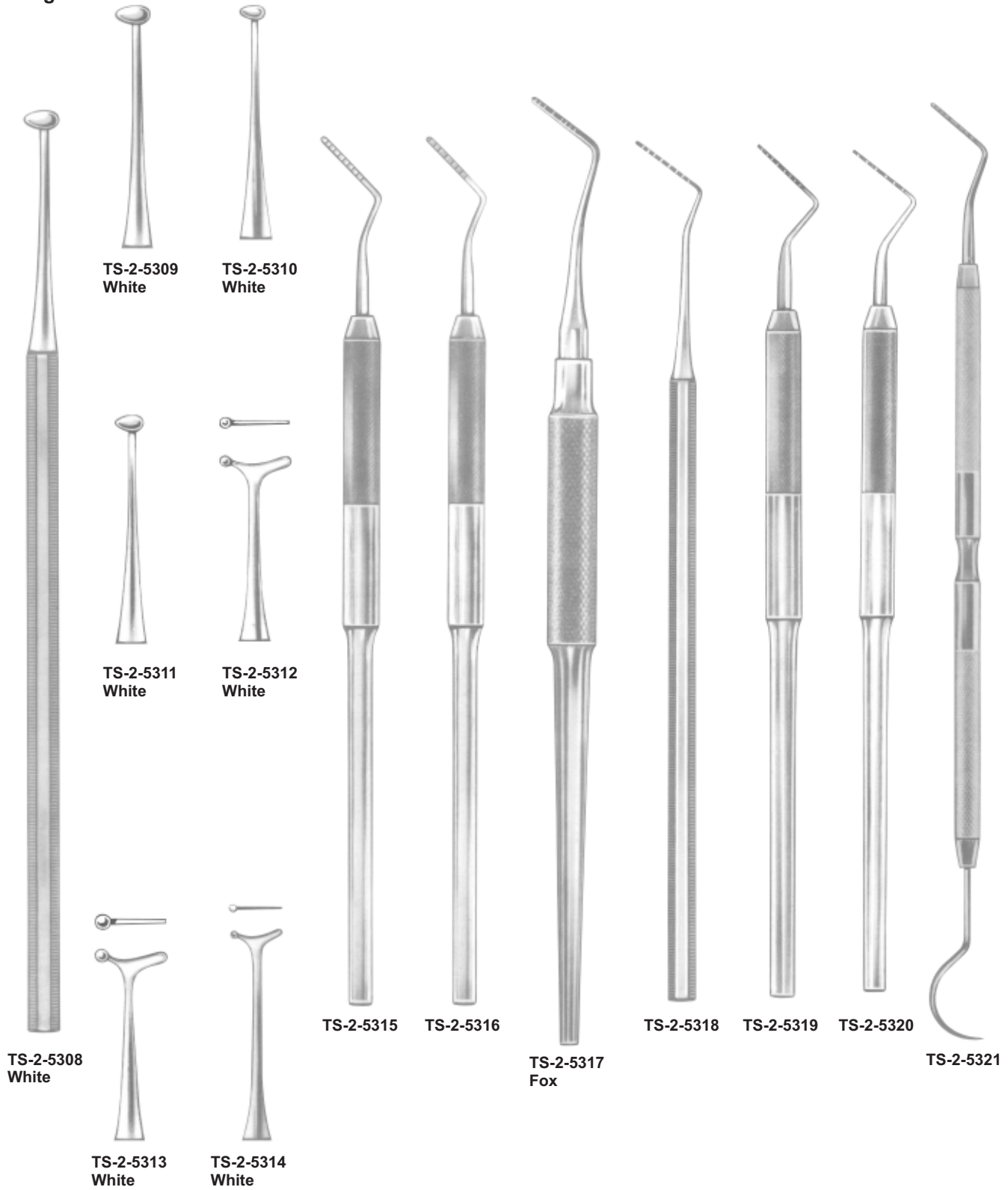



Periodontal Pocket Probes



- New marking process.
- Laser system marking.
- No more paint peeling off.
- Permanent marking.
- Antiglare, low depth marking.
- Maximum tip resistance against breaking.



TS-2-5322
Fig CP-C



TS-2-5323
Fig CP-11



TS-2-5324
Fig CP-12



TS-2-5325
Fig CP-12S
O.M.S

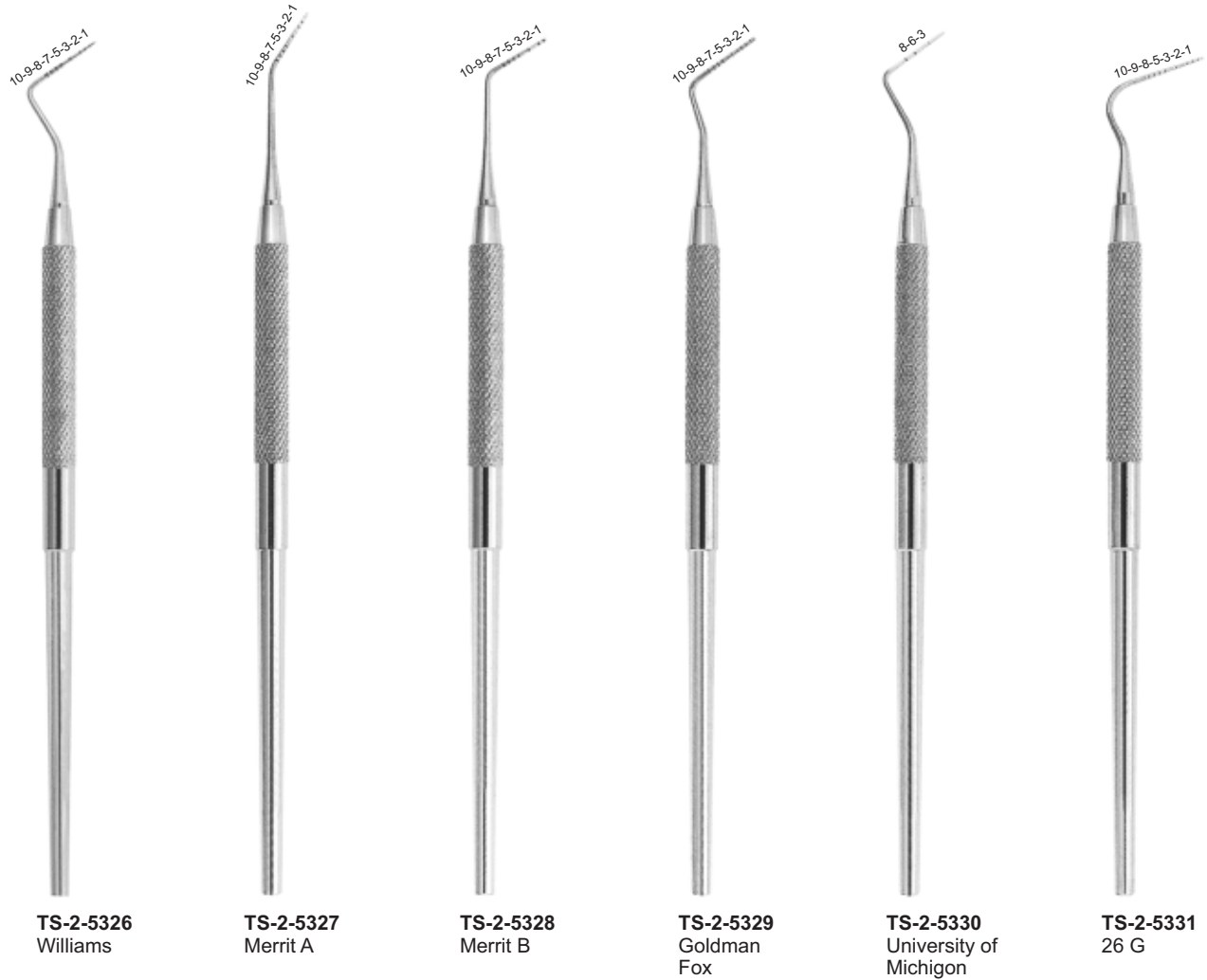

TS-2-5326
Williams

TS-2-5327
Merrit A

TS-2-5328
Merrit B

TS-2-5329
Goldman
Fox

TS-2-5330
University of
Michigan

TS-2-5331
26 G



Page
60–67

- Periodontia Instruments, Mallets





Files

Chisels

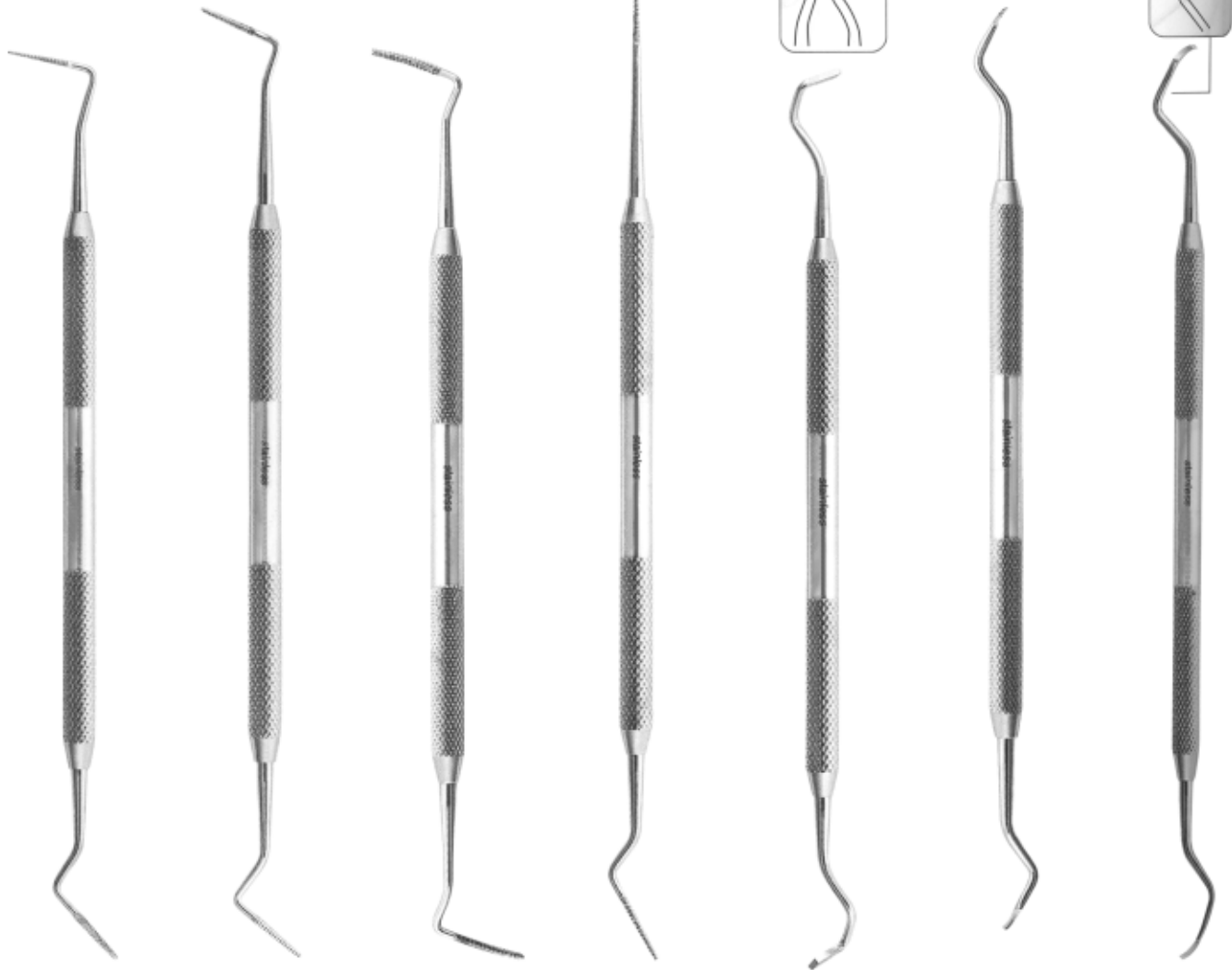

TS-3-5101
Sugarman
Fig. 1S/2S

TS-3-5102
Sugarman
Fig. 3S/4S

TS-3-5103
Schluger
Fig. 9/10

TS-3-5104
Buck
Fig. 11/12

TS-3-5105
Ochsenbein
Fig. 3

TS-3-5106
Ochsenbein
Fig. 4

TS-3-5107
Rhodes
Back - Action
Fig. 36/37



Files

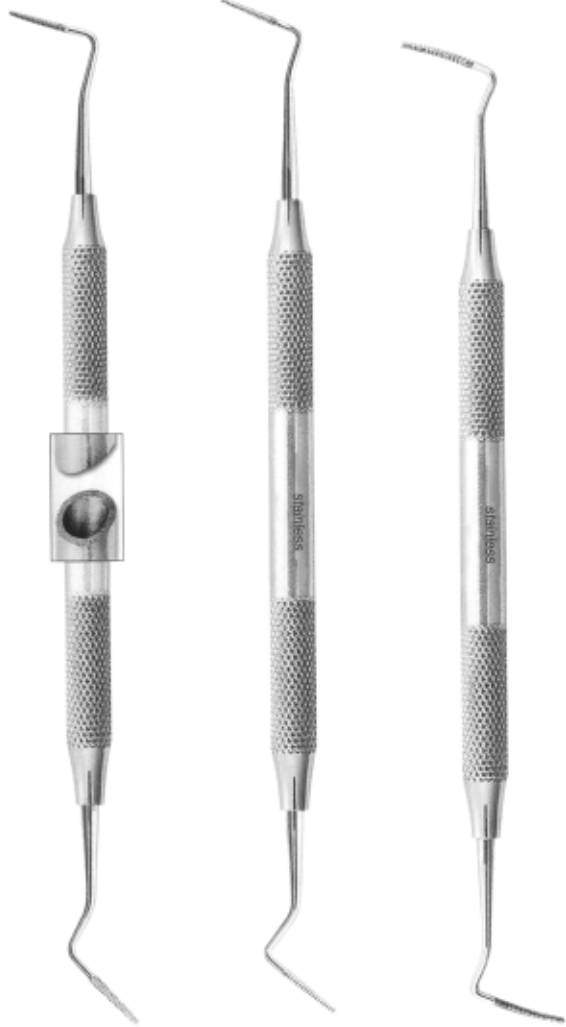

TS-3-5108
Sugarman
Fig. 1S/2S

TS-3-5109
Sugarman
Fig. 3S/4S

TS-3-5110
Schluger
Fig. 9/10



TS-3-5111
Buck
Fig. 11/12

Chisels



TS-3-5112
Ochsenbein
Fig. 3



TS-3-5113
Ochsenbein
Fig. 4



TS-3-5114
Rhodes
Back - Action
Fig. 36/37



Gingivectomy knives



TS-3-5115
Goldman-Fox
Fig. 7



TS-3-5116
Goldman-Fox
Fig. 8



TS-3-5117
Goldman-Fox
Fig. 9



TS-3-5118
Goldman-Fox
Fig. 11



TS-3-5119
Buck
Fig. 3/4



TS-3-5120
Buck
Fig. 5/6



Curettes and Scalers



TS-3-5121
Curette
Fig. HU 1/2



TS-3-5122
Columbia
Fig. 2R/2L



TS-3-5123
Columbia
Fig. 4R/4L



TS-3-5124
Columbia
Fig. 13/14



TS-3-5125
Fig. 411/412



TS-3-5126
Fig. 413/414



TS-3-5127
Zerfing-chisel



Gingivectomy knives



TS-3-5128
Goldman - Fox
Fig. 7



TS-3-5129
Goldman - Fox
Fig. 8



TS-3-5130
Goldman - Fox
Fig. 9



TS-3-5131
Goldman - Fox
Fig. 11



TS-3-5132
Buck
Fig. 3/4



TS-3-5133
Buck
Fig. 5/6



Periodontia Instruments

Curettes and Scalers



TS-3-5134
Curette
Fig. HU 1/2



TS-3-5135
Columbia
Fig. 2R/2L



TS-3-5136
Columbia
Fig. 4R/4L



TS-3-5137
Columbia
Fig. 13/14



TS-3-5138
Fig. 413/412



TS-3-5139
Fig. 411/414



TS-3-5140
Zerfing-chisel



Bone Chisels and Gouges

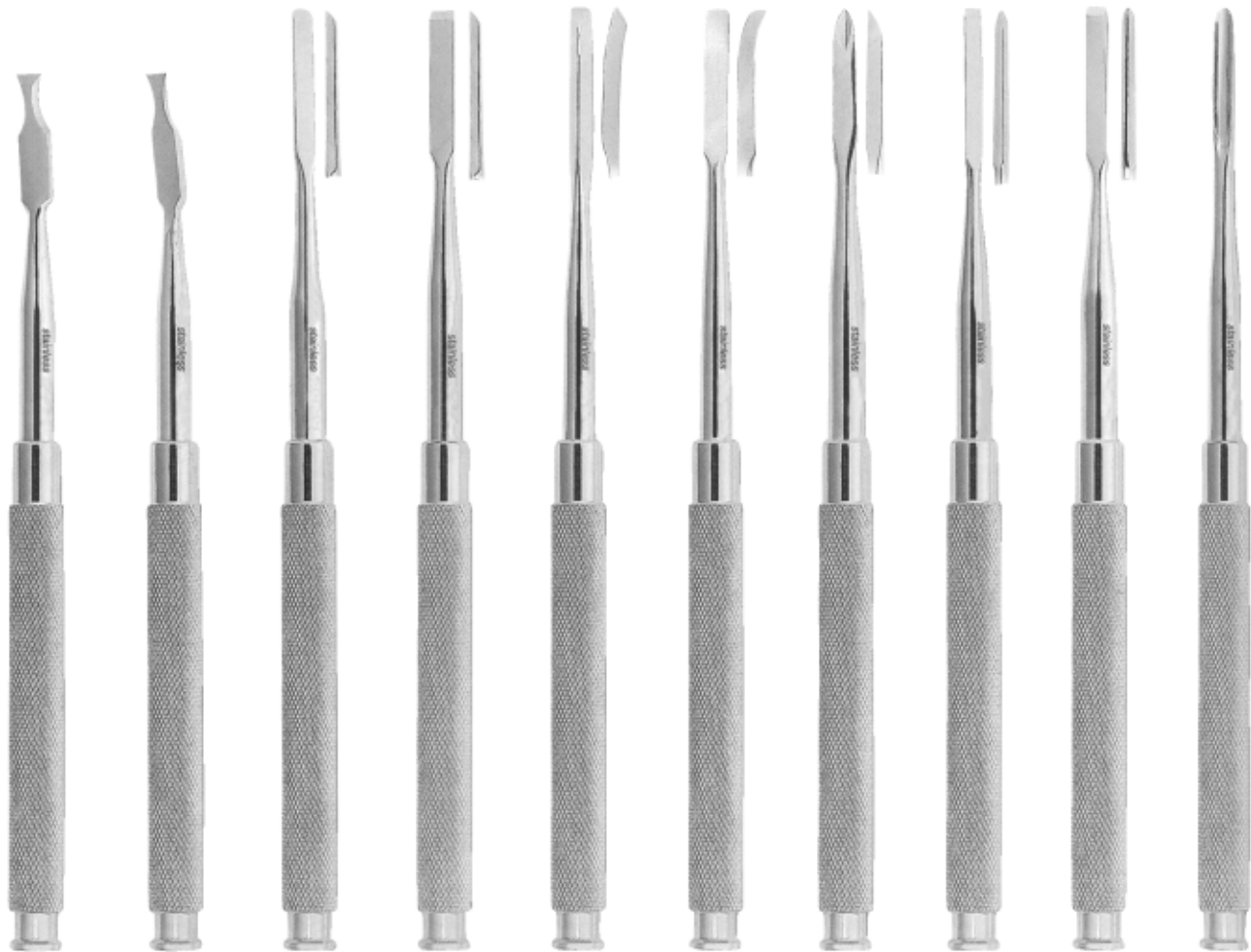

TS-3-5141
Ochsenbein
Fig. 1

TS-3-5142
Ochsenbein
Fig. 2

TS-3-5143
Gardner
Fig. 1

TS-3-5144
Gardner
Fig. 2

TS-3-5145
Gardner
Fig. 5

TS-3-5146
Gardner
Fig. 5R

TS-3-5147
Gardner
Fig. 6

TS-3-5148
Wakefield
Fig. 1W

TS-3-5149
Wakefield
Fig. 2W

TS-3-5150
Buckley
Fig. 3



Periodontia Instruments and Mallets

Bone Chisels and Gouges

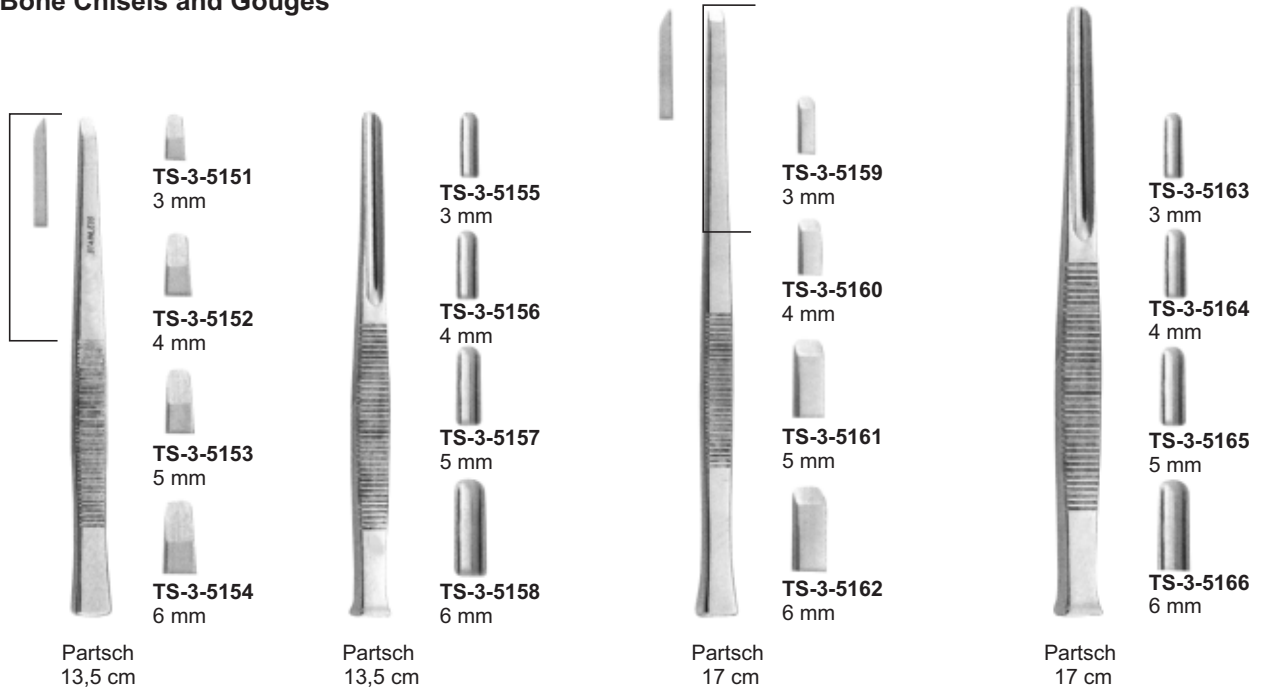

Martelli chirurgici Mallet

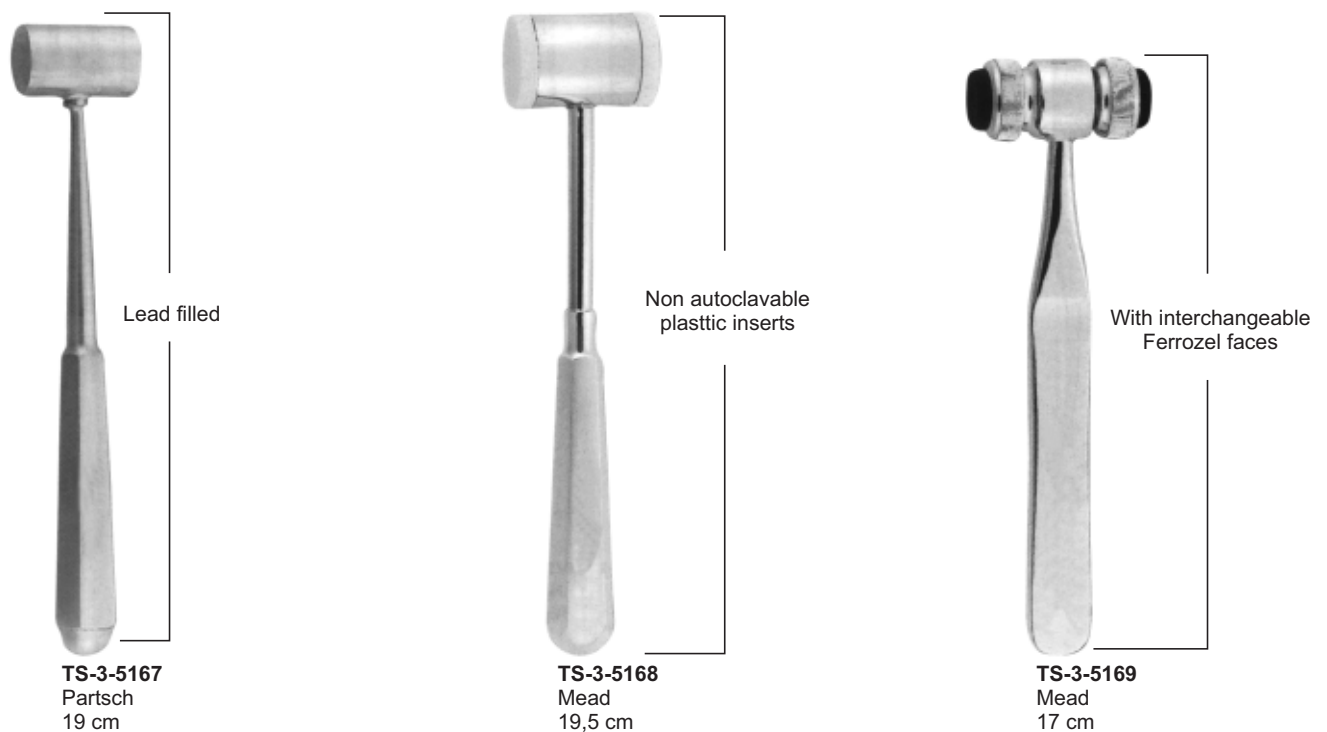



Page
68-74

- Currettes Scalers

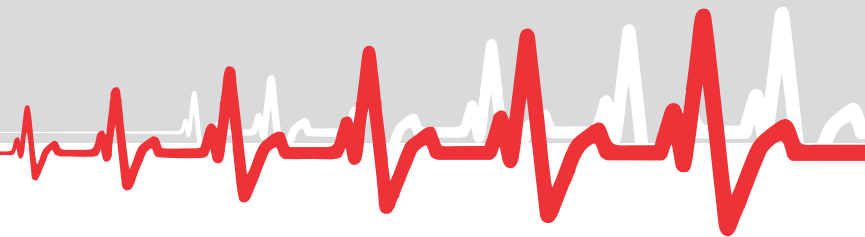

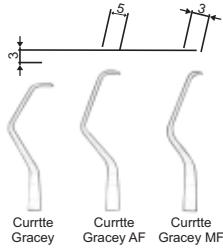

TS-3-5170
Gracey
Fig. 1/2



TS-3-5171
Gracey
Fig. 3/4



TS-3-5172
Gracey
Fig. 5/6



TS-3-5173
Gracey
Fig. 7/8



TS-3-5174
Gracey
Fig. 9/10



TS-3-5175
Gracey
Fig. 11/12



TS-3-5176
Gracey
Fig. 13/14



TS-3-5177
Gracey
Mesial Distal
Fig. 11/14



TS-3-5178
Gracey
Mesial Distal
Fig. 12/13



Gracey Curettes AF Type

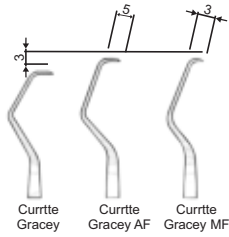

TS-3-5179
Gracey
AF/type
Fig. 1/2



TS-3-5180
Gracey
AF/type
Fig. 3/4



TS-3-5181
Gracey
AF/type
Fig. 5/6



TS-3-5182
Gracey
AF/type
Fig. 7/8



TS-3-5183
Gracey
AF/type
Fig. 11/12



TS-3-5184
Gracey
AF/type
Fig. 13/14



TS-3-5185
Gracey
AF/type
Fig. 15/16



TS-3-5187
Gracey
AF/type
Fig. 1/2



TS-3-5188
Gracey
AF/type
Fig. 3/4



TS-3-5189
Gracey
AF/type
Fig. 5/6



TS-3-5190
Gracey
AF/type
Fig. 7/8



TS-3-5191
Gracey
AF/type
Fig. 11/12



TS-3-5192
Gracey
AF/type
Fig. 13/14



TS-3-5193
Gracey
AF/type
Fig. 15/16



TS-3-5186
Gracey
AF/type



TS-3-5194
Gracey
MF/type
Fig. 1/2



TS-3-5195
Gracey
MF/type
Fig. 3/4



TS-3-5196
Gracey
MF/type
Fig. 5/6



TS-3-5197
Gracey
MF/type
Fig. 7/8



TS-3-5198
Gracey
MF/type
Fig. 11/12



TS-3-5199
Gracey
MF/type
Fig. 13/14



TS-3-5200
Gracey
MF/type
Fig. 15/16



Gracey Curettes AF Type

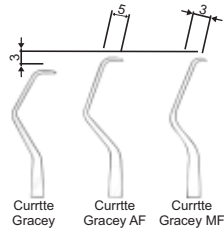

TS-3-5201
Gracey
MF/type
Fig. 1/2



TS-3-5202
Gracey
MF/type
Fig. 3/4



TS-3-5203
Gracey
MF/type
Fig. 5/6



TS-3-5204
Gracey
MF/type
Fig. 7/8



TS-3-5205
Gracey
MF/type
Fig. 11/12



TS-3-5206
Gracey
MF/type
Fig. 13/14



TS-3-5207
Gracey
MF/type
Fig. 15/16



TS-3-5208
Goldman - Fax
Fig. 1



TS-3-5209
Goldman - Fax
Fig. 2



TS-3-5210
Goldman - Fax
Fig. 3



TS-3-5211
Goldman - Fax
Fig. 4



TS-3-5212
Goldman - Fax
Fig. 21

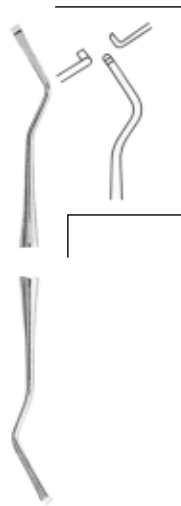

TS-3-5213
Goldman - Fax
Fig. 5



TS-3-5214
Mc Call
Fig. 13S/14S

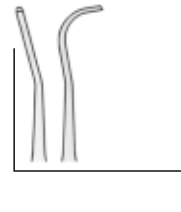

TS-3-5215
Younger-Good
Fig. 7/8



Curettes and Scalers

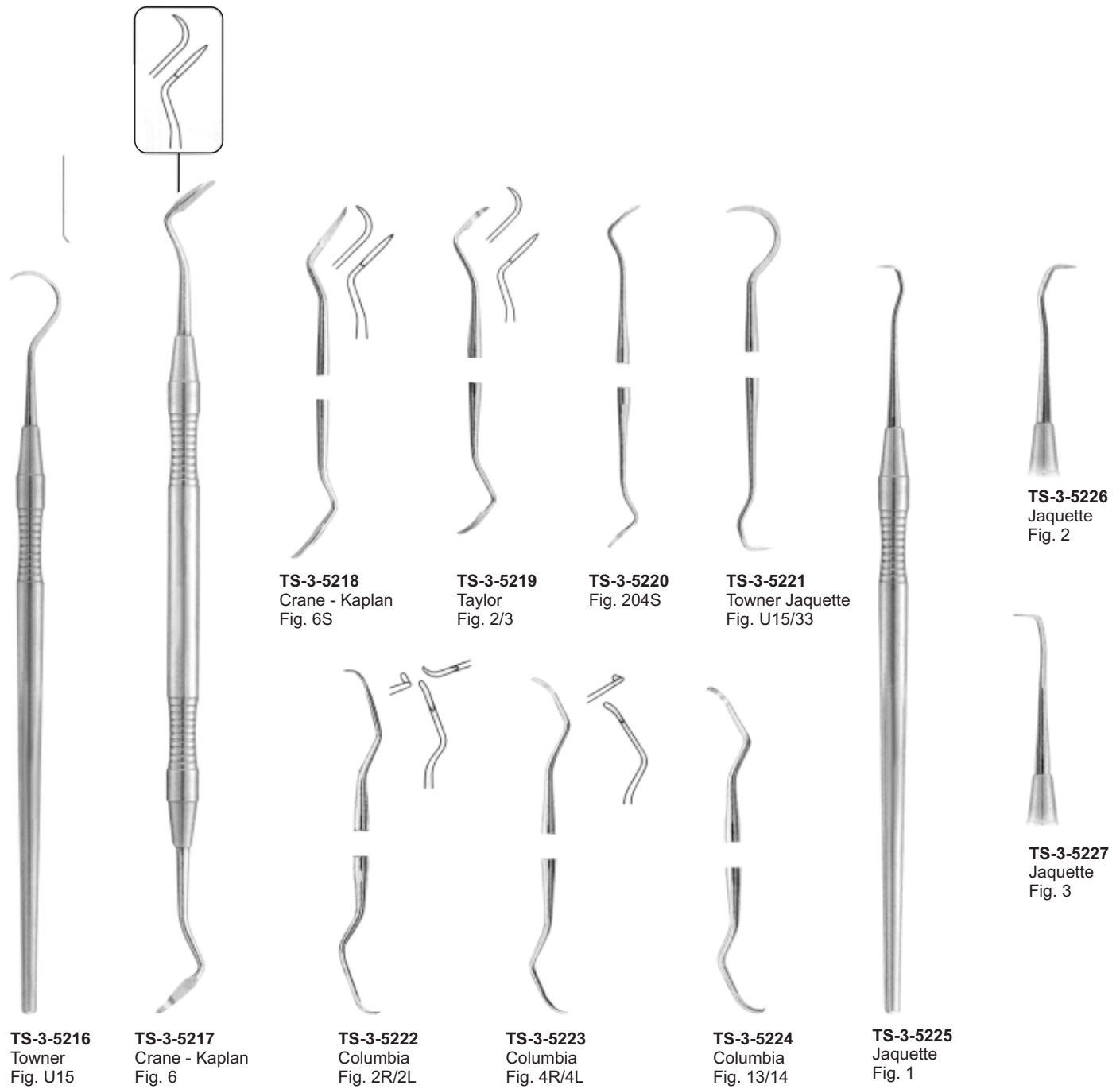

TS-3-5216
Towner
Fig. U15

TS-3-5217
Crane - Kaplan
Fig. 6

TS-3-5218
Crane - Kaplan
Fig. 6S

TS-3-5219
Taylor
Fig. 2/3

TS-3-5220
Fig. 204S

TS-3-5221
Towner Jaquette
Fig. U15/33

TS-3-5226
Jaquette
Fig. 2

TS-3-5222
Columbia
Fig. 2R/2L

TS-3-5223
Columbia
Fig. 4R/4L

TS-3-5224
Columbia
Fig. 13/14

TS-3-5227
Jaquette
Fig. 3

TS-3-5225
Jaquette
Fig. 1



TS-3-5228
Hemingway
Fig. 1



TS-3-5229
Hemingway
Fig. 2



TS-3-5230
Hemingway
Fig. 3



TS-3-5231
Lucas
Fig. 85



TS-3-5232
Lucas
Fig. 86



TS-3-5233
Lucas
Fig. 87



Page
75-77

- Modelling Instruments & Measuring Instruments

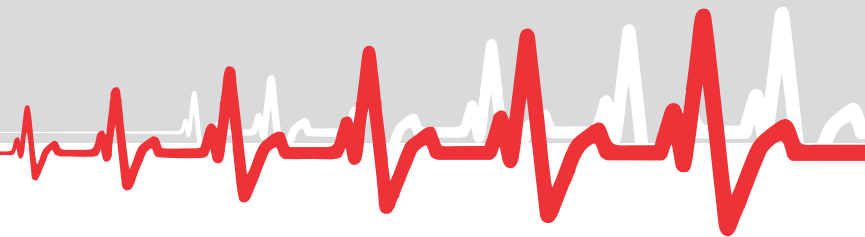

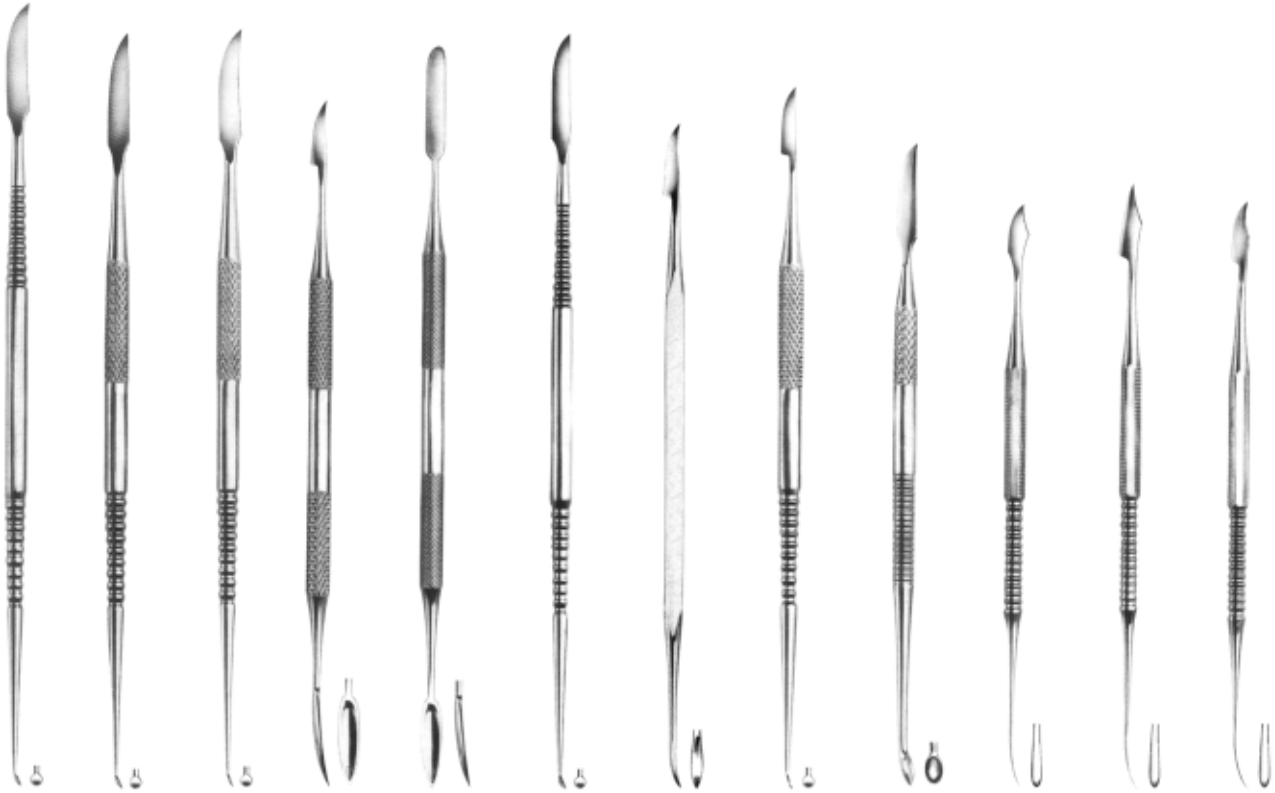

TS-4-5101 Le Cron **TS-4-5102** Le Cron **TS-4-5103** Le Cron **TS-4-5104** MSY **TS-4-5105** MSY **TS-4-5106** Le Cron **TS-4-5107** Hylin **TS-4-5108** Hylin **TS-4-5109** Hylin **TS-4-5110** Zahle **TS-4-5111** Zahle **TS-4-5112** Zahle

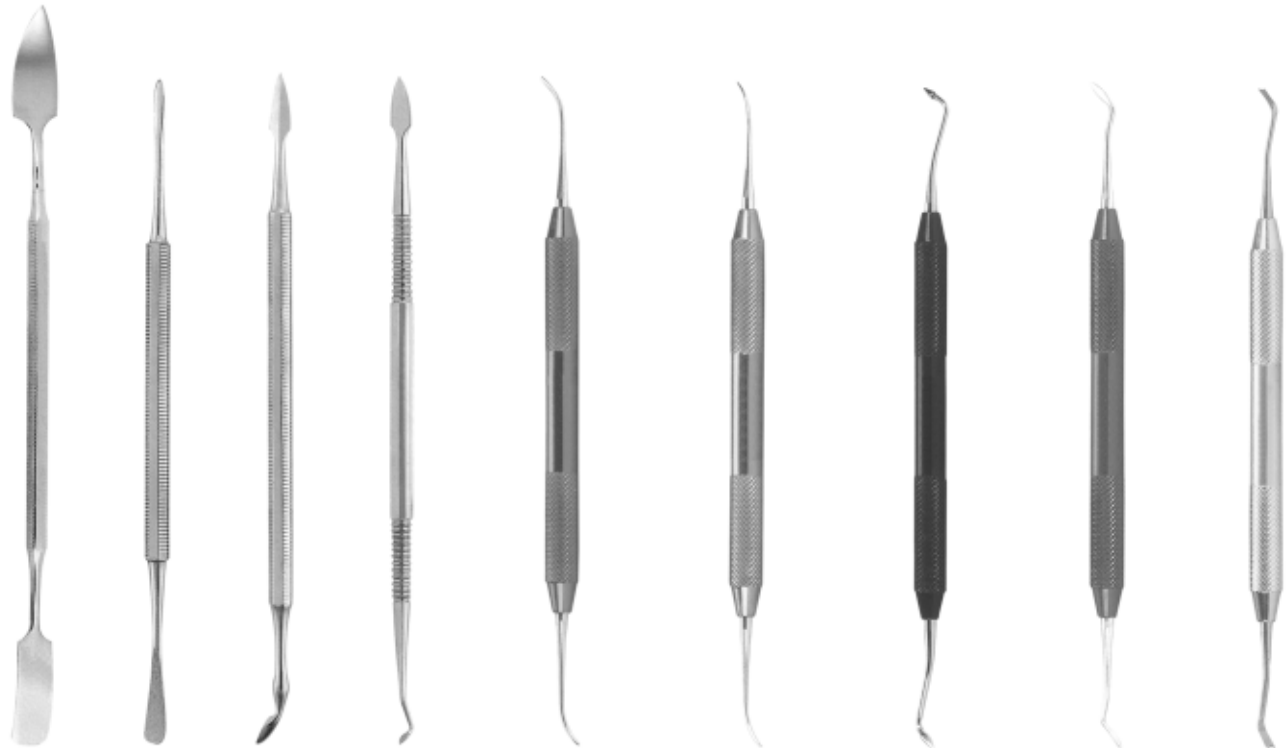

TS-4-5113 Gritman **TS-4-5114** Beale **TS-4-5115** Roach **TS-4-5116** Vehe **TS-4-5117** P.K. Thomas Fig. 1 **TS-4-5118** P.K. Thomas Fig. 2 **TS-4-5119** P.K. Thomas Fig. 3 **TS-4-5120** P.K. Thomas Fig. 4 **TS-4-5121** P.K. Thomas Fig. 5



Measuring Instruments



TS-4-5122
Boley



TS-4-5123
Zuricher
130 mm



TS-4-5124
Vernier
12 cm



TS-4-5125
Vernier

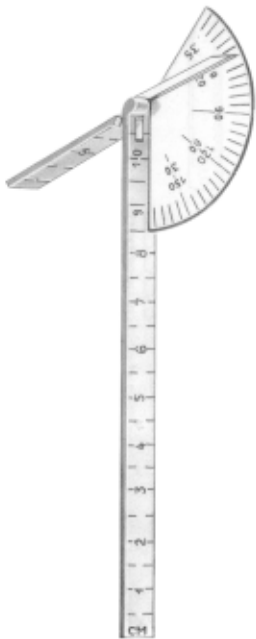

TS-4-5126
Caroll



TS-4-5127
Castroviejo's
Scleral Marker



TS-4-5128
Iwanson



TS-4-5129
Albee



TS-4-5130
18 cm
7 1/8"



TS-4-5131
18 cm
7 1/8"



TS-4-5132
17 cm
6 3/4"
Gritman

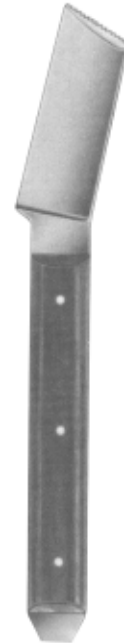

TS-4-5133
17 cm
6 3/4"
Medicon



TS-4-5134
22 cm
8 3/4"



TS-4-5135
Antkoviak



TS-4-5136
Ermert



TS-4-5137
Ermert



Page
78–79

▪ Wax Knives/plaster





TS-4-5138
Fahnenstock
Fig. 1
12,5cm



TS-4-5139
Fahnenstock
Fig. 2
17cm



TS-4-5140
Lessmann
Fig. 1
12,5cm



TS-4-5141
Lessmann
Fig. 2
17cm



TS-4-5142
Con scodellino
Fig. 1
12,5cm



TS-4-5143
Con scodellino
Fig. 2
17cm

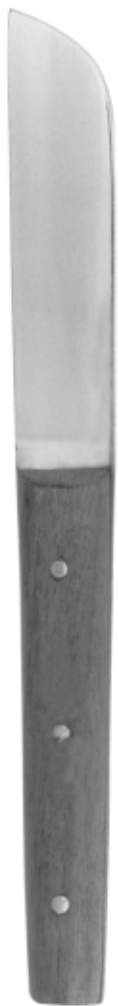

TS-4-5144
Fig. 1
17 cm



TS-4-5145
Gritman
Fig. 2
17 cm



TS-4-5146
Fig. 3
16 cm



TS-4-5147
Fig. 4
16 cm



Page
80–85

▪ Diagnostic, Explorer, Endodontic Instruments





Explorers



TS-4-5148
Fig 23



TS-4-5149
Fig 6



TS-4-5150
Fig 8



TS-4-5151
Fig 9



TS-4-5152
Fig 17



TS-4-5153
Fig 3
Rein



TS-4-5154
Fig 23/17



TS-4-5155
Fig 17

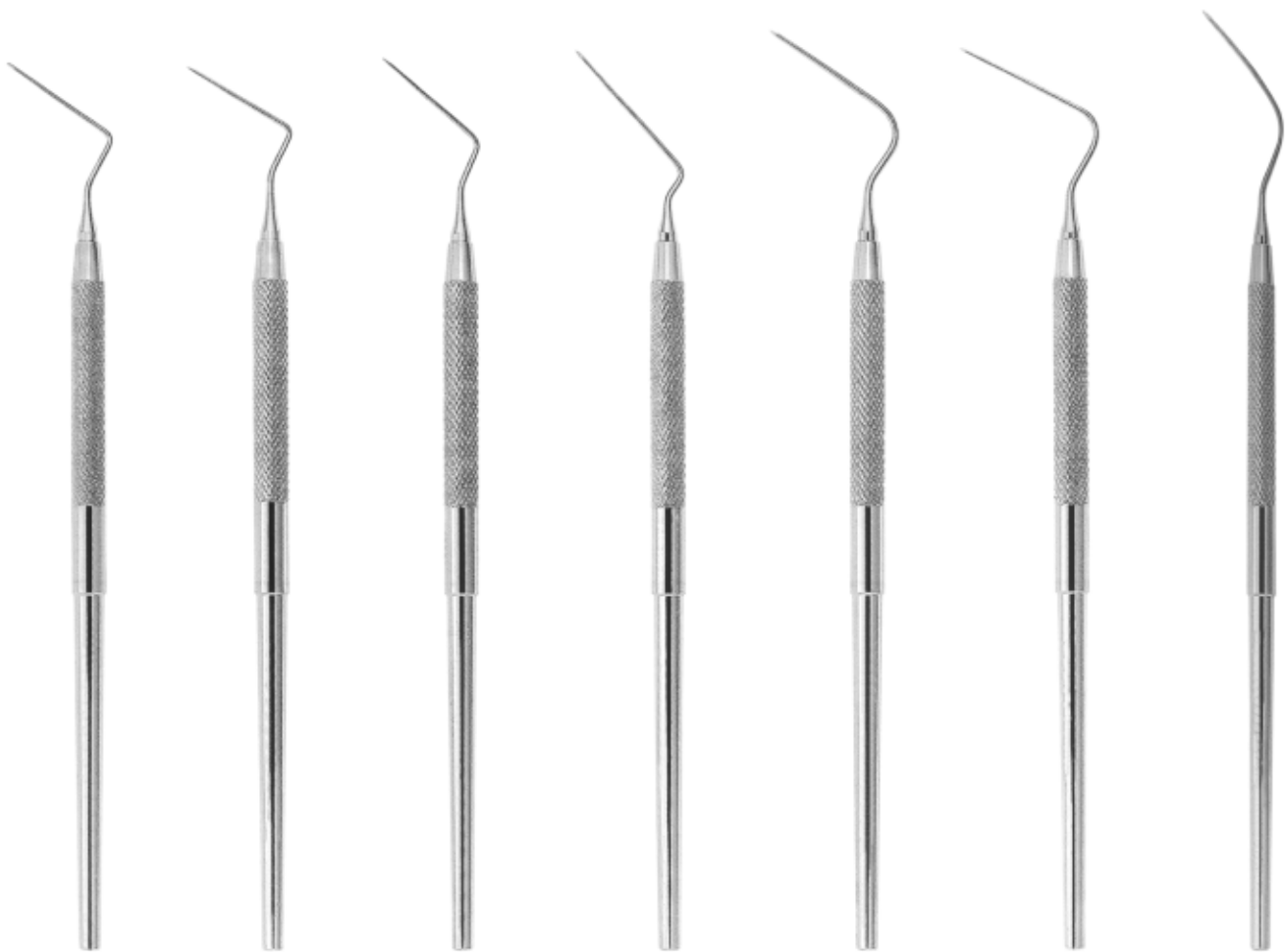

TS-4-5156
Fig.1
Spreader

TS-4-5157
Fig.2
Spreader

TS-4-5158
Fig.3
Spreader

TS-4-5159
Fig.4
Spreader

TS-4-5110
Fig.5
Spreader

TS-4-5111
Fig.6
Spreader

TS-4-5112
Fig.7
Spreader



Endodontic Instruments

Double-Ended Root Canal Explorers Plugger/Spreaders

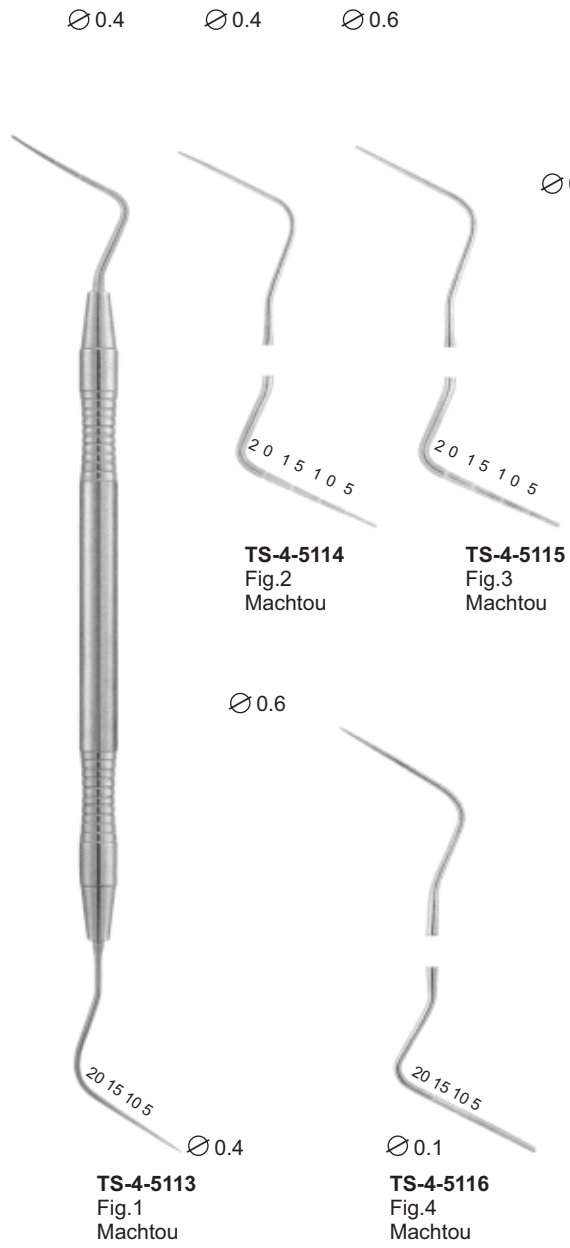

Spreaders

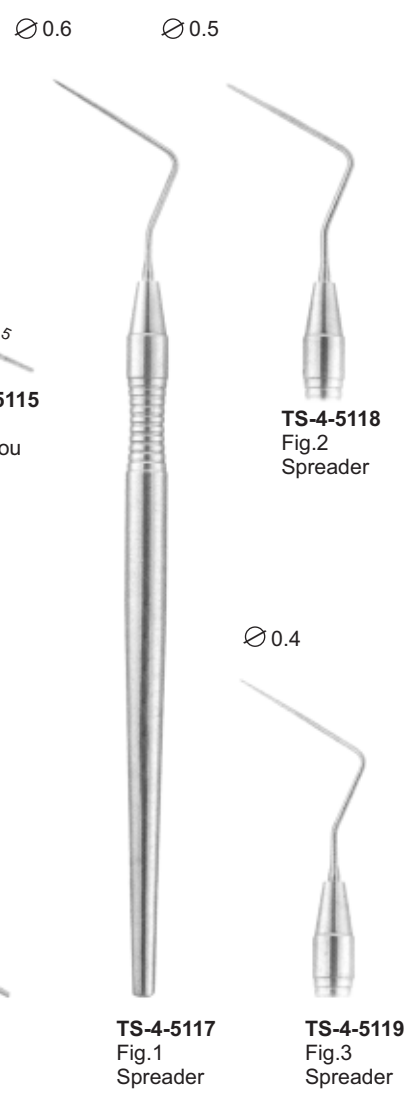

Periodontal Pocket Probes

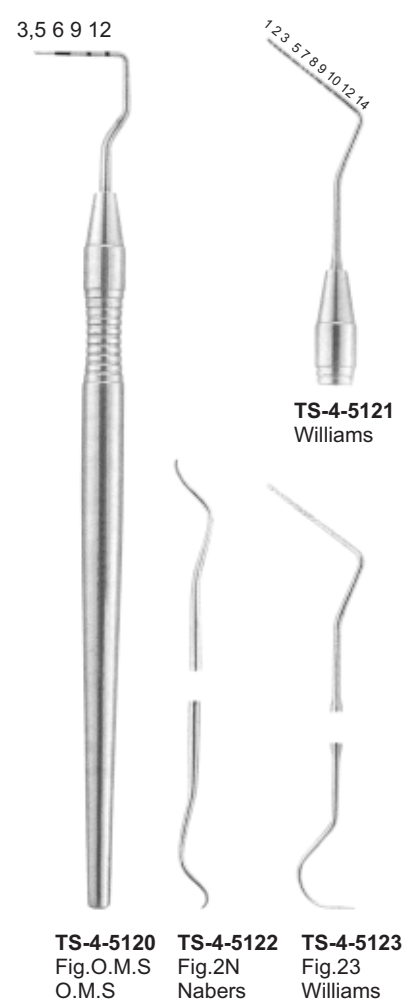



Root-canal pluggers

Ø 0.5



TS-4-5124
Fig.1
Luks

Ø 0.7



TS-4-5125
Fig.2
Luks

Ø 0.9



TS-4-5126
Fig.3
Luks

Ø 1.1



TS-4-5127
Fig.4
Luks

Ø 0.5



TS-4-5128
Fig.1
Vertical
condenser

Ø 0.7



TS-4-5129
Fig.2
Vertical
condenser

Ø 0.9



TS-4-5130
Fig.3
Vertical
condenser

Ø 1.1



TS-4-5131
Fig.4
Vertical
condenser

Endodontic set



TS-4-5132
Measuring Plate



Endodontic Instruments

Root-canal pluggers

Optimum Flexibility
Very Fine Points

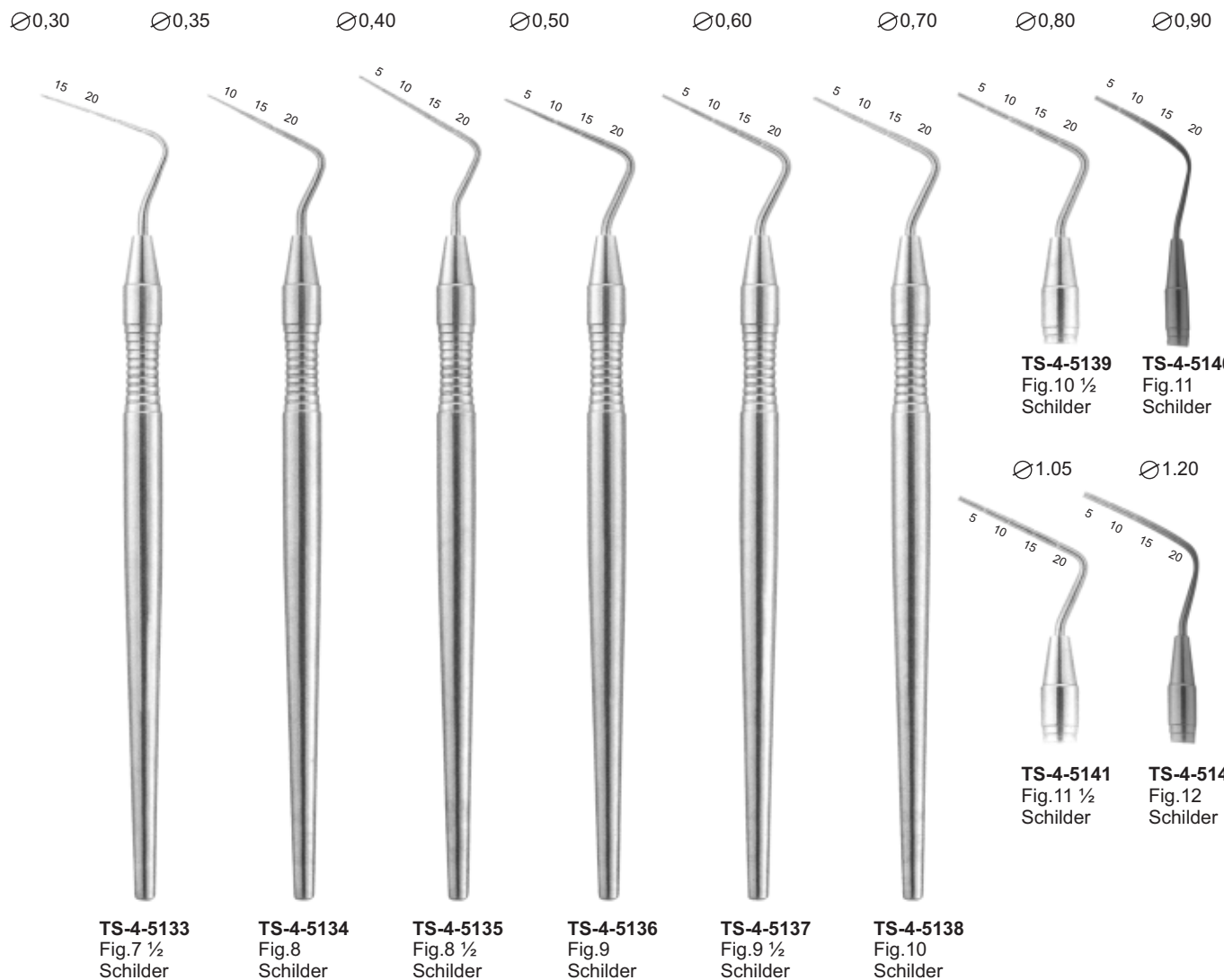



Root-canal explorers

Root-canal excavators



TS-4-5143
Fig.6/1



TS-4-5144
Fig.6/17



TS-4-5145
Fig.6/23



TS-4-5146
Fig.31L



TS-4-5147
Fig.32L



TS-4-5148
Fig.33L



Page
86-87

- Excavators

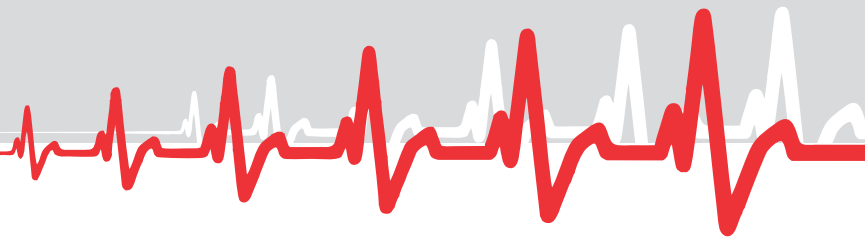

Excavators



1 mm



TS-4-5149
Fig 5

1.2 mm



TS-4-5150
Fig 14

1 mm



TS-4-5151
Fig 17

1.2 mm



TS-4-5152
Fig 18

1.6 mm



TS-4-5153
Fig 19

2 mm



TS-4-5154
Fig 20



1 mm



TS-4-5155
ASH
Fig.243

1,4 mm



TS-4-5156
ASH
Fig.G2

0,8 mm



TS-4-5157
Fig.1

0,8 mm



TS-4-5158
Fig.2

1 mm



TS-4-5159
Fig.11

1 mm



TS-4-5160
Fig.12

1,2 mm



TS-4-5161
Fig.21

1,2 mm



TS-4-5162
Fig.22

1,6 mm



TS-4-5163
Fig.31

1,6 mm



TS-4-5164
Fig.32

2 mm



TS-4-5165
Fig.41

2 mm



TS-4-5166
Fig.42



Page
88-89

- Handles For Mouth Mirrors

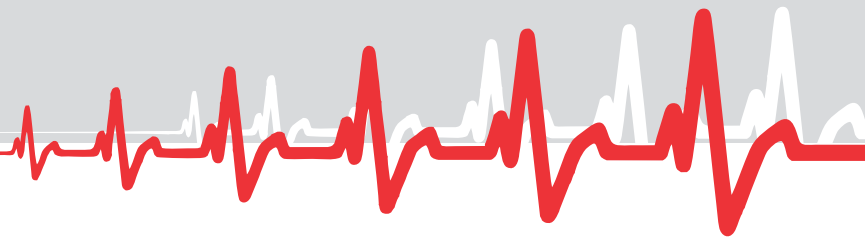

Plane



TS-5-5104
Fig.6
Ø 26 mm



TS-5-5105
Fig.5
Ø 24 mm



TS-5-5106
Fig.4
Ø 22 mm



TS-5-5107
Fig.4
Rhodium
Ø 22 mm

Front surface
mouth mirrors

Set of 5 pieces



TS-5-5101



TS-5-5102



TS-5-5103

Hollow,
stainless
steel

Magnifying



TS-5-5108
Fig.6
Ø 26 mm



TS-5-5109
Fig.5
Ø 24 mm



TS-5-5110
Fig.4
Ø 22 mm



TS-5-5111
Fig.5
Rhodium
Ø 24 mm



Handles for Mouth Mirrors and Mouth Mirrors



TS-5-5112



TS-5-5113



TS-5-5114



TS-5-5115



TS-5-5116



TS-5-5117
Parallelometer
mouth mirror



TS-5-5118
Parallelometer
mouth mirror
+ handle
code 2101

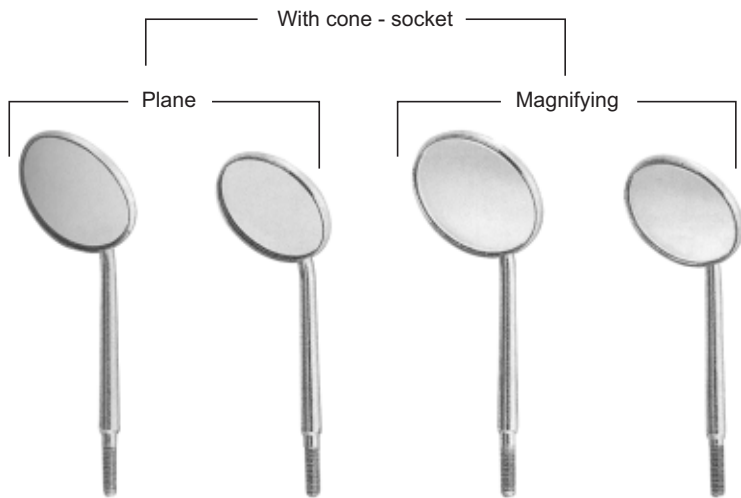

TS-5-5119
Fig.5
Ø24 mm

TS-5-5120
Fig.4
Ø22 mm

TS-5-5121
Fig.5
Ø 24 mm

TS-5-5122
Fig.4
Ø 22 mm



TS-5-5123
Cone - socket



TS-5-5124
Cone - socket



TS-5-5125
Cone - socket



Page
90–93

- Spatulas

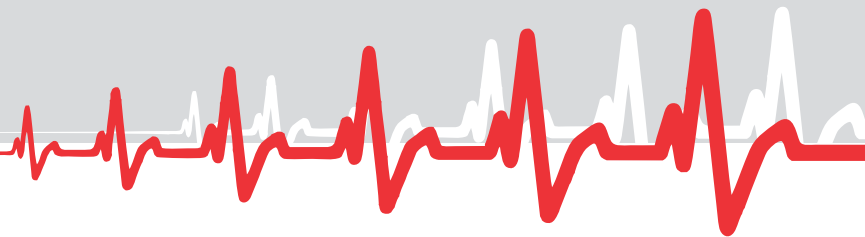



TS-5-5126



TS-5-5127



TS-5-5128



TS-5-5129

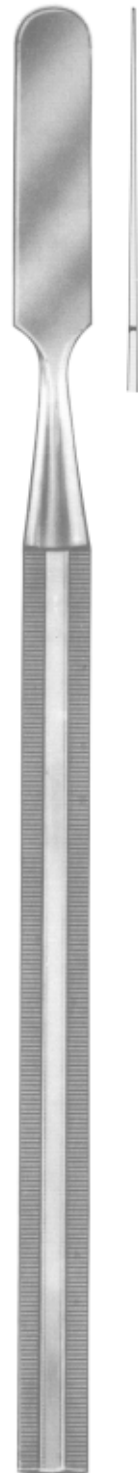

TS-5-5130



TS-5-5131



TS-5-5132



TS-5-5133

Cement Spatulas

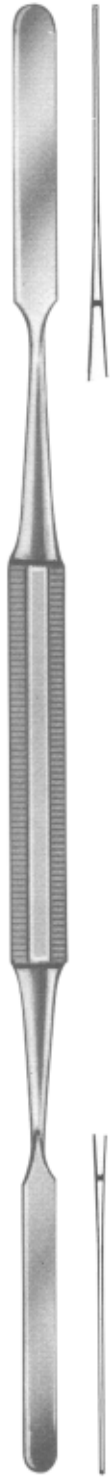

TS-5-5134

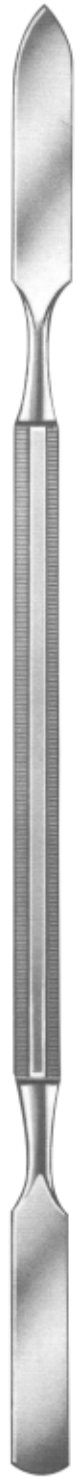

TS-5-5135



TS-5-5136

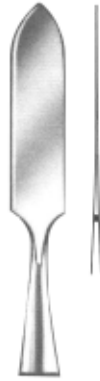

TS-5-5137



TS-5-5138



TS-5-5139



TS-5-5140



TS-5-5136



TS-5-5137



TS-5-5138



TS-5-5139



TS-5-5140



TS-5-5141
Fig. 1
18.5 cm

TS-5-5142
Fig. 2
18 cm

TS-5-5143
Fig. 3
18.5 cm

TS-5-5144
Fig. 4
19.5 cm

TS-5-5145
Fig. 5
21.5 cm

TS-5-5146
Fig. 6
20.5 cm



Spatulas for Plaster and Alginate



TS-5-5147
Fig. 7
19.5 cm

TS-5-5148
Fig. 8
20 cm

TS-5-5149
Fig. 9
22.5 cm



Page
94-100

- Needle Holders

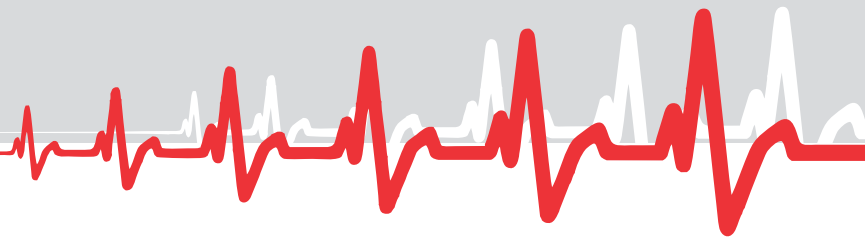



TS-5-5150
Mayo-Hegar
16 cm



TS-5-5151
Mayo-Hegar TC
16 cm



TS-5-5152
Mayo-Hegar
18 cm



TS-5-5153
Mayo-Hegar TC
18 cm



TS-5-5154
Mini-Ryder
18 cm



TS-5-5155
Mini-Ryder
15 cm



TS-5-5156
Derf
12 cm



TS-5-5157
Hegar-Baumgarther
14 cm



Needle Holders



TS-5-5158
Crile-Wood
15 cm



TS-5-5159
Crile-Wood TC
15 cm



TS-5-5160
Adson
17.5 cm



TS-5-5161
Olsen-Hegar
14 cm



TS-5-5162
Baumgarther
14.5 cm



TS-5-5163
Gillies
16 cm



TS-5-5164
Gillies
16 cm



TS-5-5165
Hegar-Baumgarther
14 cm



TS-5-5166
Toennis
18 cm



TS-5-5167
Toennis
18 cm



TS-5-5168
Lichtenberg
17 cm



TS-5-5169
Lichtenberg
17 cm



TS-5-5170
Eiselberg-Mathieu
19.5 cm



TS-5-5171
Boynton
12 cm



TS-5-5172
Arruga
16 cm



TS-5-5173
Boynton
12 cm



TS-5-5174
Arruga
16 cm



Needle Holders



TS-5-5175
Castroviejo
14 cm



TS-5-5176
Castroviejo
14 cm



TS-5-5177
Castroviejo
14/60 cm



TS-5-5178
Castroviejo
18 cm



TS-5-5179
Castroviejo
18 cm



TS-5-5180
Castroviejo
14 cm



TS-5-5181
Castroviejo
14 cm



TS-5-5182
Castroviejo
14/60 cm



TS-5-5183
Castroviejo
18 cm



TS-5-5184
Castroviejo
18 cm



TS-5-5185
Mathieu
14 cm



TS-5-5186
Mathieu
14 cm



TS-5-5187
Mathieu
14 cm



TS-5-5188
Mathieu
14 cm



TS-5-5189
Mathieu
17 cm



TS-5-5190
Mathieu
17 cm



TS-5-5191
Mathieu
14 cm



TS-5-5192
Micro-Barraquer
18 cm



Needle Holders & Stainless Steel Saliva Ejectors



The tips have tungsten carbide inserts for better handling.



TS-5-5193
Mathieu
17 cm



TS-5-5194
Mathieu
17 cm



TS-5-5195
Micro-Barraquer
14 cm



TS-5-5196
Castroviejo
13 cm



TS-5-5197
Castroviejo-Barraquer
13 cm



TS-5-5198
Castroviejo
13 cm



TS-5-5199
Castroviejo
13 cm

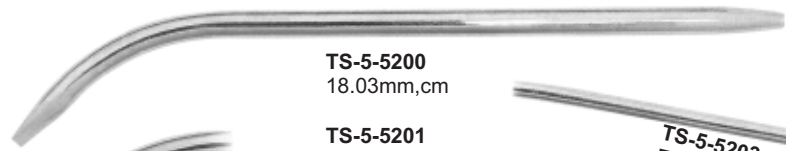

TS-5-5200
18.03mm,cm



TS-5-5201
18.04mm,cm



TS-5-5202
18.05mm,cm



TS-5-5203
Fig. 12FR
Fraizer
15.04mm,cm



TS-5-5204
Fig. 10FR
Fraizer
15.03,3mm,cm

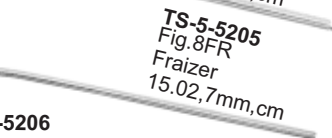

TS-5-5205
Fig. 8FR
Fraizer
15.02,7mm,cm



TS-5-5206
Fig. 6FR
Fraizer
15.02mm,cm

0.4  **TS-5-5207**
12.5 cm

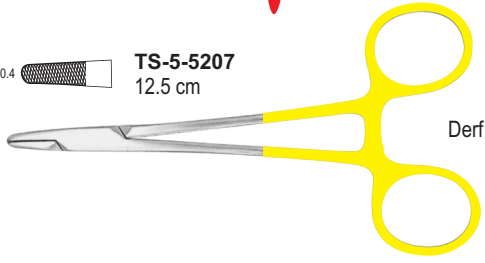

Derf

0.4  **TS-5-5214**
14 cm



Mathieu
Kocher

0.4  **TS-5-5215**
17 cm



Mathieu

0.4  **TS-5-5208**
13 cm

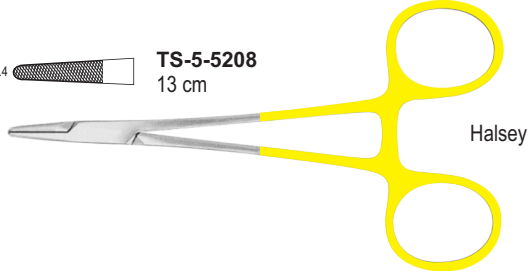

Halsey

0.4  **TS-5-5216**
14 cm

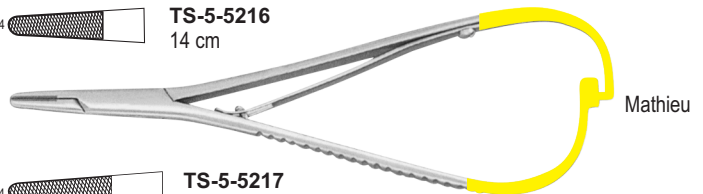

Mathieu

0.5  **TS-5-5209**
14.5 cm

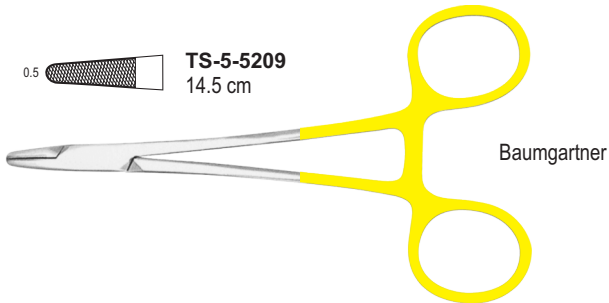

Baumgartner

0.4  **TS-5-5217**
17 cm



Mathieu

0.4  **TS-5-5218**
14 cm

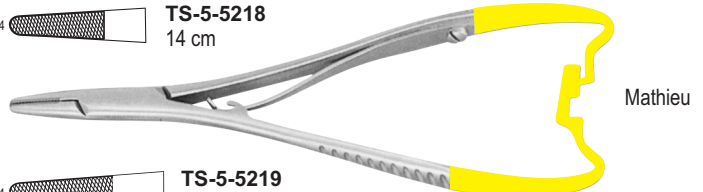

0.4  **TS-5-5219**
17 cm

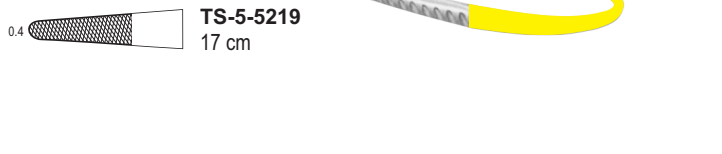

Mathieu

0.4  **TS-5-5210**
15 cm

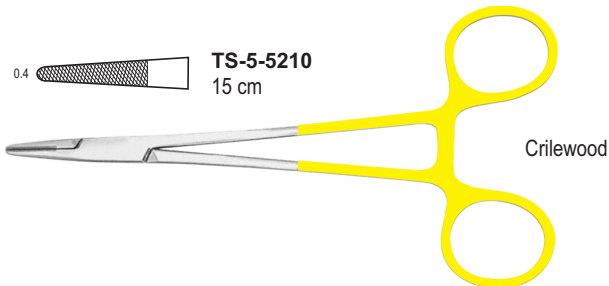

Crilewood

0.4  **TS-5-5220**
14 cm

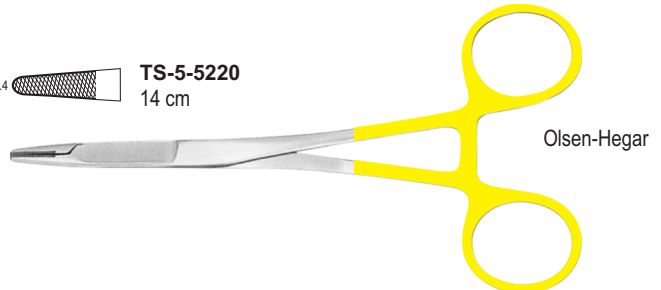

Olsen-Hegar

0.4  **TS-5-5211**
15 cm

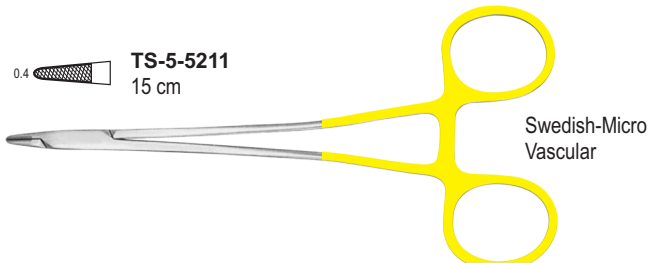

Swedish-Micro
Vascular

0.5  **TS-5-5221**
18 cm



Toennis

0.5  **TS-5-5212**
16 cm

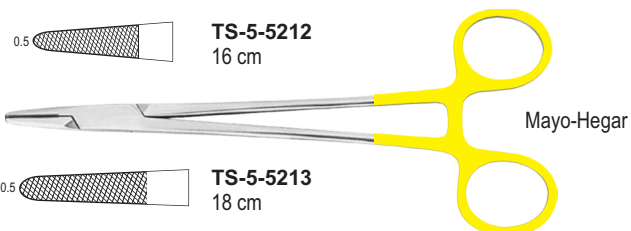

Mayo-Hegar

0.5  **TS-5-5213**
18 cm



Page
101-109

- Syringes and Scissors

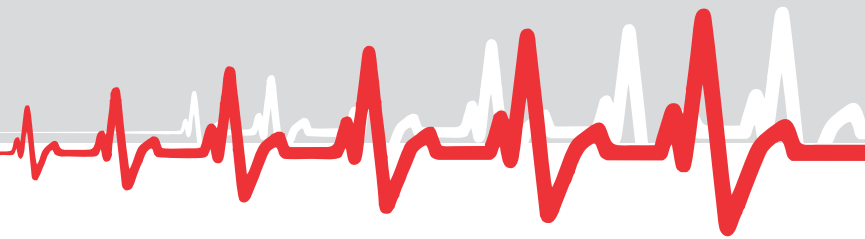

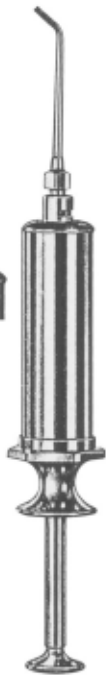

TS-5-5222

Water Syringe complete with 1 cannula (Lure-Lock)



TS-5-5223

Water Syringe complete with 1 cannula (Lure-Lock)



TS-5-5224

Metal water syringe, self-filling, with 1 cannula (Lure-Lock)



TS-5-5225

Sparrel Barrel with plunger suitable for syringes



TS-5-5226

Cannula, only, with Luer-Lock connector suitable for syringes



TS-5-5227
Aspirating Syringe

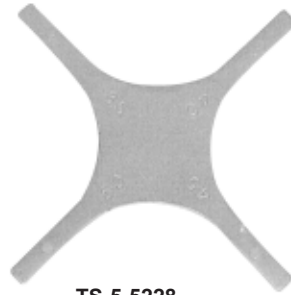

TS-5-5228
Position Gauge

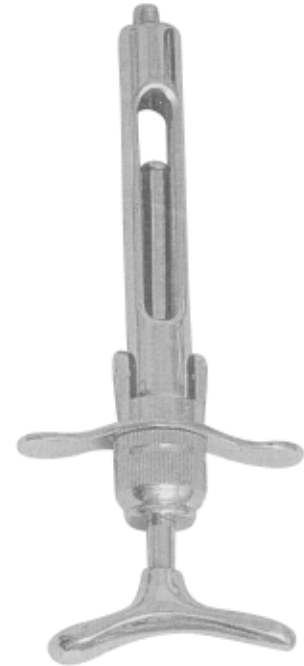

TS-5-5229
Breech Loading Syringe



TS-5-5230
Aspirating & Breech Syringe



TS-5-5231
Band Adaptor



TS-5-5232
Endo Finger Ruler
With Adjustable Slide

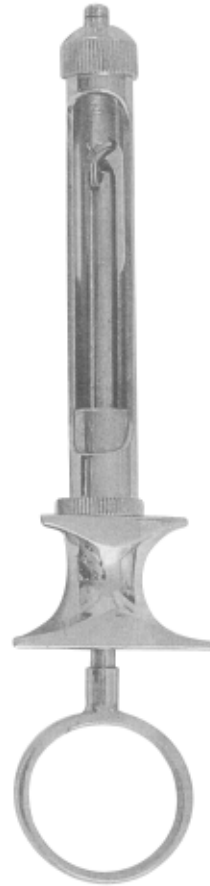

TS-5-5233
Aspirating Syringe



TS-5-5234



TS-5-5235



TS-5-5236

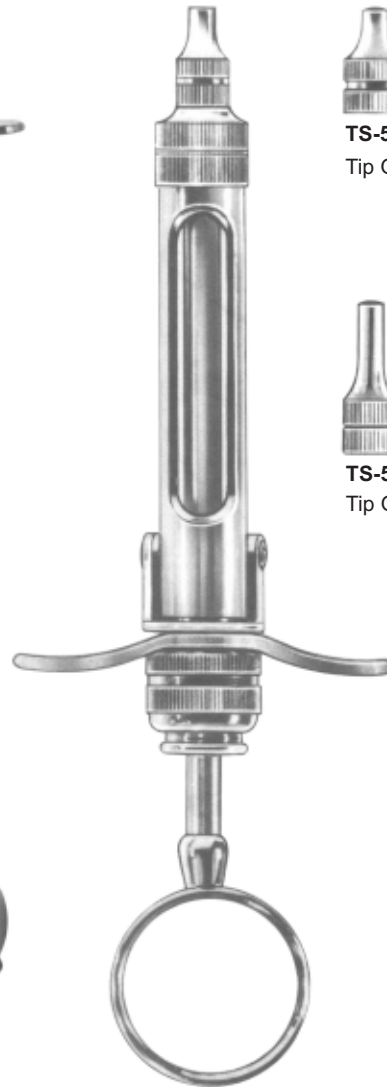

TS-5-5237 1,8 ml
TS-5-5238 2,2 ml

Cartridge Syringe complete
With 2 tips and without needles



TS-5-5239
Tip Only, short



TS-5-5240
Tip Only, long



TS-5-5241



TS-5-5242



TS-5-5243



TS-5-5244
Cork screw tip



TS-5-5245
Cork screw tip



TS-5-5246
Folding type, cork screw tip



TS-5-5247
Folding type, cork screw tip



TS-5-5248



TS-5-5249
Cork screw tip



TS-5-5250
Spare cap with metric thread



TS-5-5251
With Whitworth thread

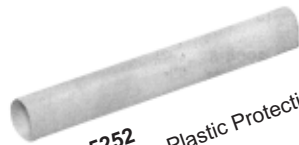

TS-5-5252
Autoclavable Plastic Protection sleeve



TS-5-5253
Brass syringe with stainless steel moving parts

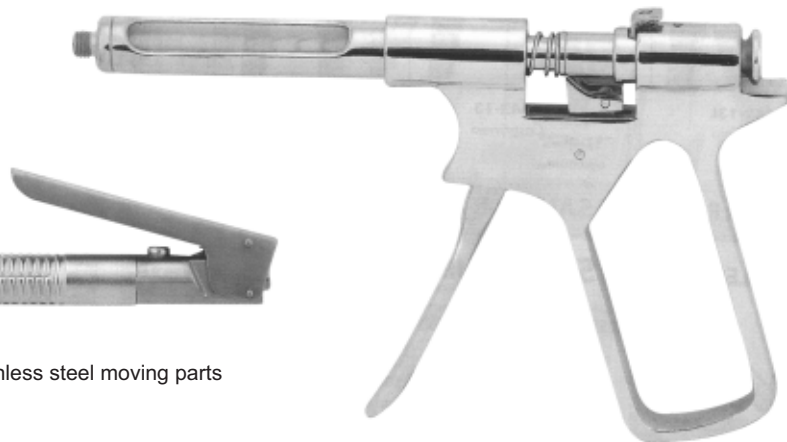

TS-5-5254
Brass syringe with stainless steel moving parts



Operating Scissors

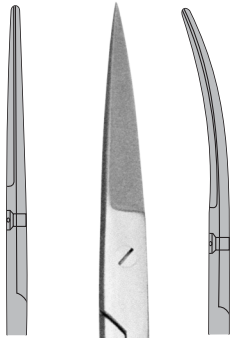

TS-5-5255
11.5 cm
TS-5-5256
13 cm
TS-5-5257
14 cm

TS-5-5258
11.5 cm
TS-5-5259
13 cm
TS-5-5260
14 cm



Standard
Sharp / Sharp

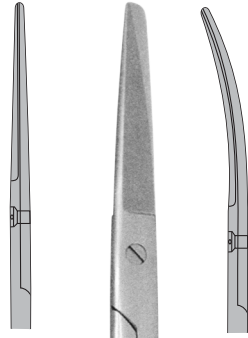

TS-5-5261
11.5 cm
TS-5-5262
13 cm
TS-5-5263
14 cm

TS-5-5264
11.5 cm
TS-5-5265
13 cm
TS-5-5266
14 cm



Standard
Blunt / Sharp

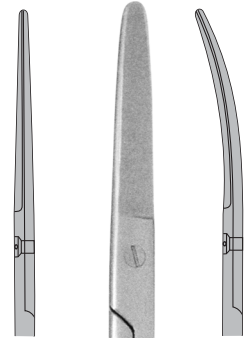

TS-5-5267
11.5 cm
TS-5-5268
13 cm
TS-5-5269
14 cm

TS-5-5270
11.5 cm
TS-5-5271
13 cm
TS-5-5272
14 cm



Standard
Blunt / Blunt

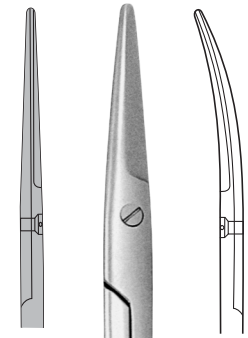

TS-5-5273

TS-5-5274



Mayo
14.5 cm

Suture Scissors | Tijeras para Hilos | Fadenscheren

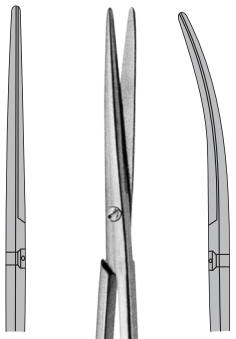

TS-5-5275

TS-5-5276 **TS-5-5277**



Metzenbaum-Delicate
14.5 cm

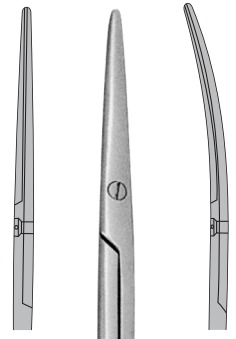

TS-5-5278



Metzenbaum
14.5 cm

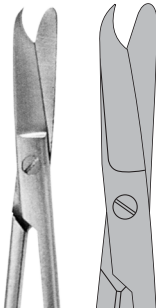

TS-5-5279
Littauer
14 cm

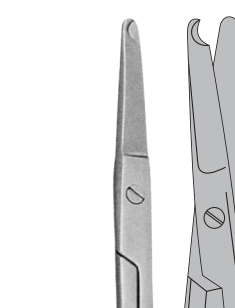

Spencer
TS-5-5280 9 cm
TS-5-5281 13 cm



Bandage Scissors Lister
TS-5-5282 9 cm
TS-5-5283 11 cm
TS-5-5284 14 cm
TS-5-5285 18 cm



TS-5-5286 TS-5-5287 TS-5-5288 TS-5-5289

Iris
11.5 cm

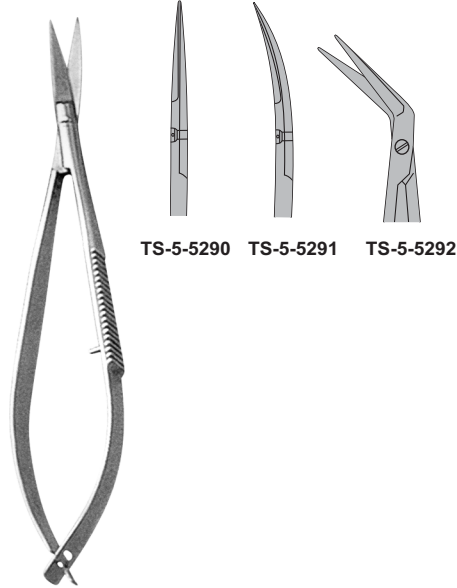

TS-5-5290 TS-5-5291 TS-5-5292

Noyes / Castroviejo
12 cm

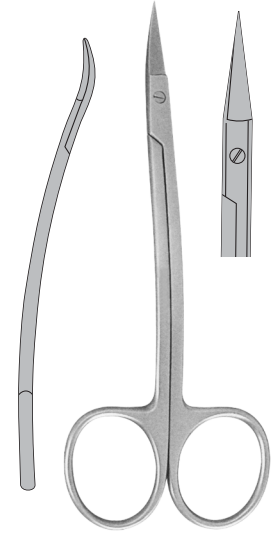

TS-5-52903
La Grange
11.5 cm



TS-5-5294
Universal
18 cm

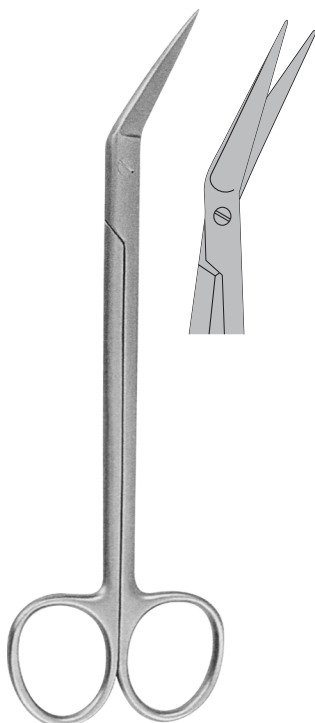

TS-5-5295
Kelly
16 cm

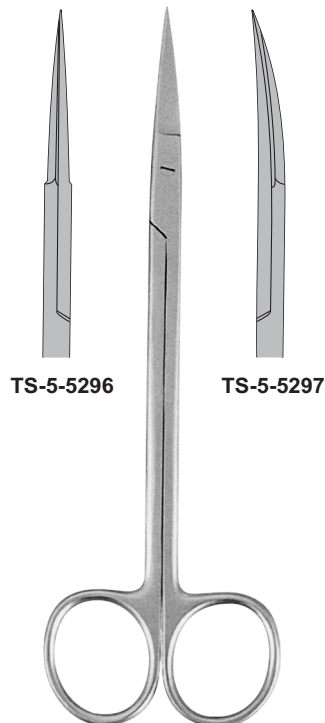

TS-5-5296

TS-5-5297

Kelly
16 cm



TS-5-5298
Goldman-Fox
13 cm

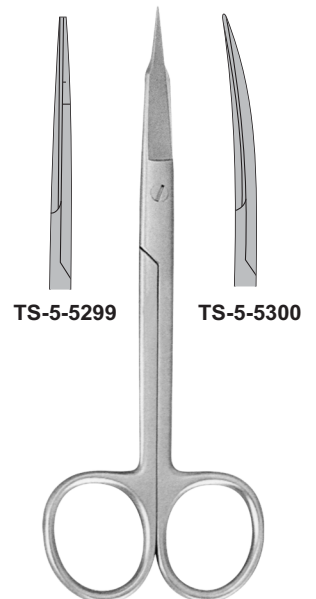

TS-5-5299

TS-5-5300

Goldman-Fox
13 cm



Scissors

Scissors, One Blade Serrated

- One blade is with fine serrations to avoid tissue or ligature slippage.
- Manufactured from high quality stainless steel to provide longer-lasting cutting edge.
- Single black ring for easy identification.



TS-5-5301 TS-5-5302 TS-5-5303 TS-5-5304



Iris
11.5 cm

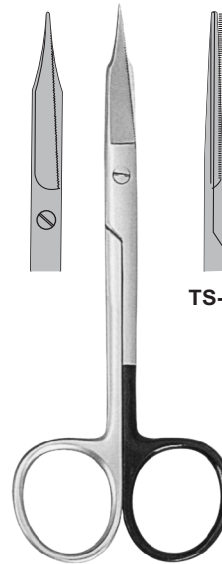

Goldman-Fox
13 cm

TS-5-5305



TS-5-5306
Goldman-Fox
13 cm

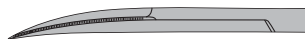

TS-5-5307

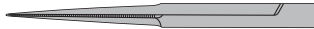

TS-5-5308

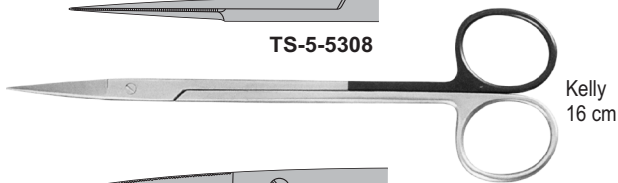

Kelly
16 cm

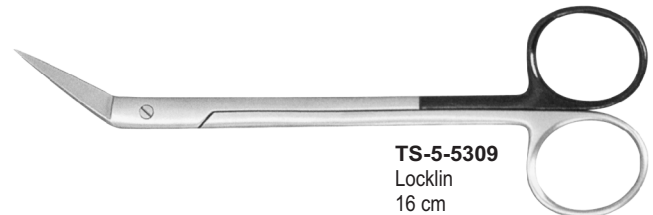

TS-5-5309
Locklin
16 cm

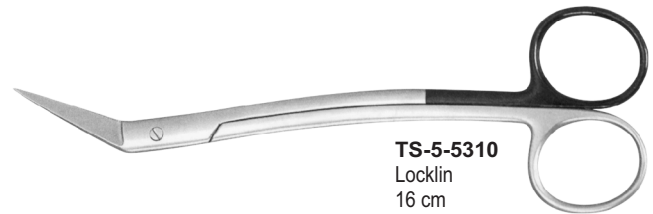

TS-5-5310
Locklin
16 cm

Super-Cut

- Cutting Blade horned to "razor" sharpness with opposing blade finished with fine serrations to avoid tissue slippage.
- Extremely smooth cutting with less trauma.
- Manufactured from high quality stainless steel to provide longer-lasting cutting edge.
- Single gold plated ring for easy identification.

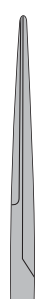

TS-5-5311



TS-5-5312



Iris
11.5 cm

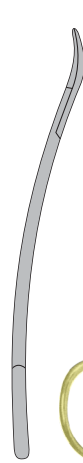

TS-5-5313
La Grange
11.5 cm



TS-5-5314



TS-5-5315



Goldman-Fox
13 cm

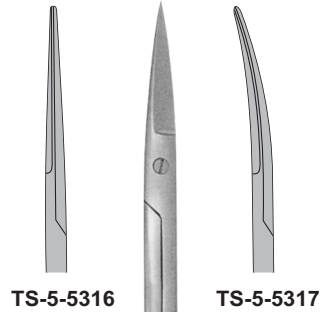

Iris
11.5 cm

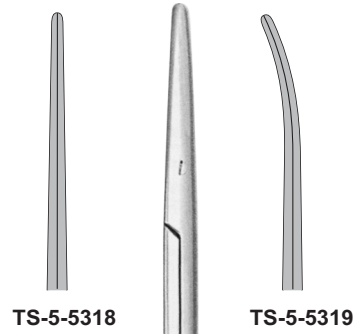

Metzenbaum
14.5 cm

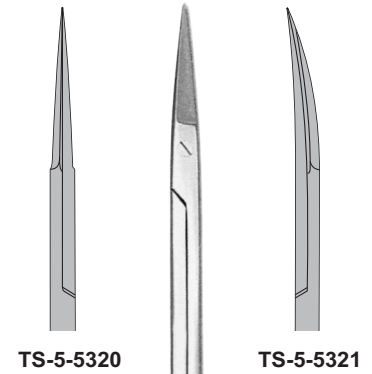

Kelly
16 cm

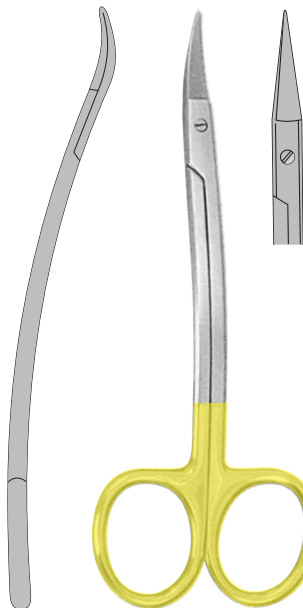

La Grange
11.5 cm

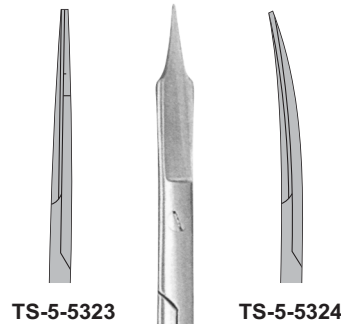

Goldman-Fox
13 cm

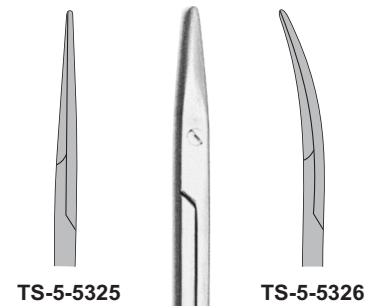

Strabismus
11.5 cm



Micro Scissors

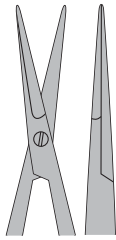
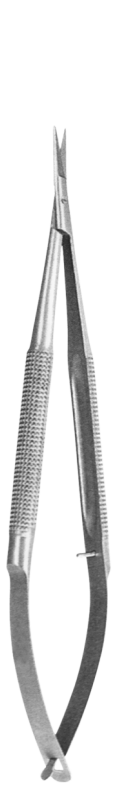

TS-5-5327
15 cm

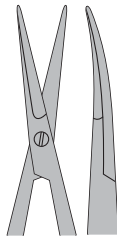

TS-5-5328
15 cm

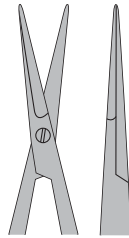
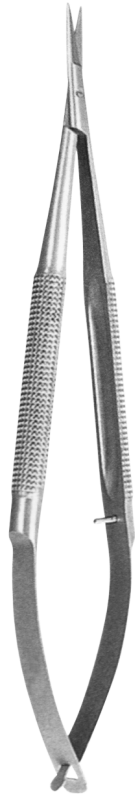

TS-5-5329
18 cm

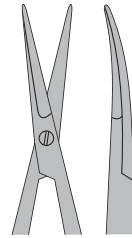

TS-5-5330
18 cm

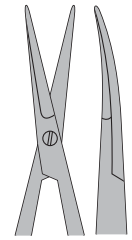
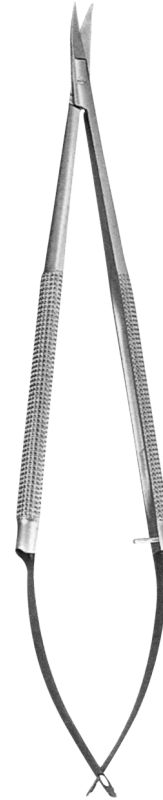

TS-5-5331
18 cm

Micro Scissor
Stainless Steel

Micro Scissor
Stainless Steel

Micro Scissor
Stainless Steel
for ligature, one blade serrated

Micro Scissors with Titanium Stainless Steel Tips

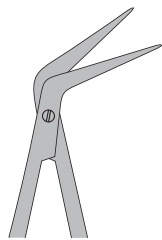
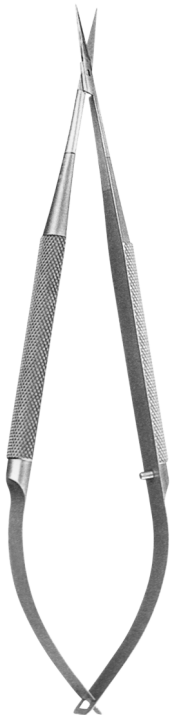

TS-5-5332
18 cm

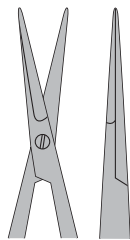

TS-5-5333
18 cm

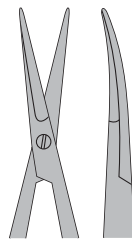

TS-5-5334
18 cm

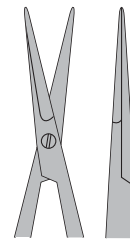

TS-5-5335
15.5 cm

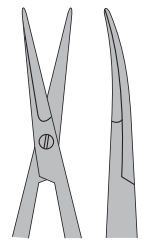

TS-5-5336
15.5 cm



Page
110-114

- Dental Tweezers

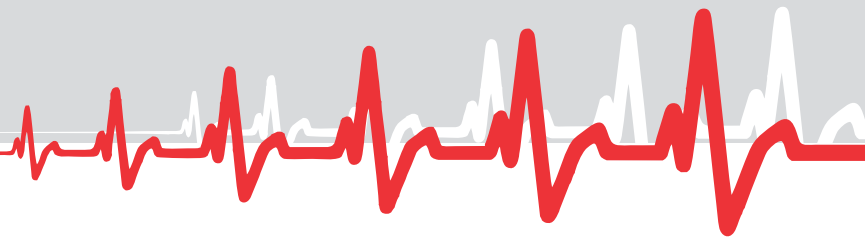



smooth

TS-5-5337
College
15 cm



serrated

TS-5-5338
College
15 cm



smooth

TS-5-5339
College
15 cm



serrated

TS-5-5340
College
15 cm



smooth

TS-5-5341
College
15 cm



serrated

TS-5-5342
College
15 cm



smooth

TS-5-5343
College
15 cm



serrated

TS-5-5344
College
15 cm



Dental Tweezers

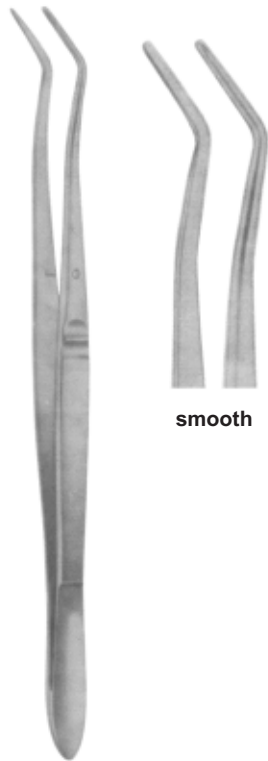

smooth

TS-5-5345
Meriam
16 cm

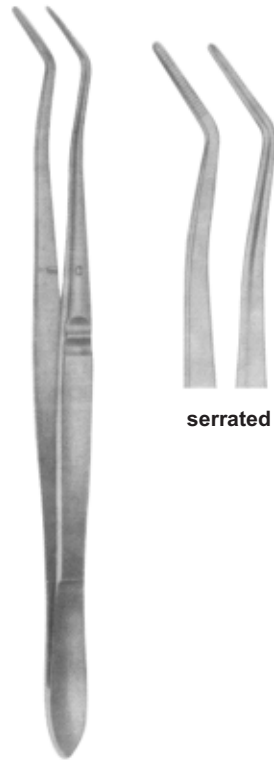

serrated

TS-5-5346
Meriam
16 cm

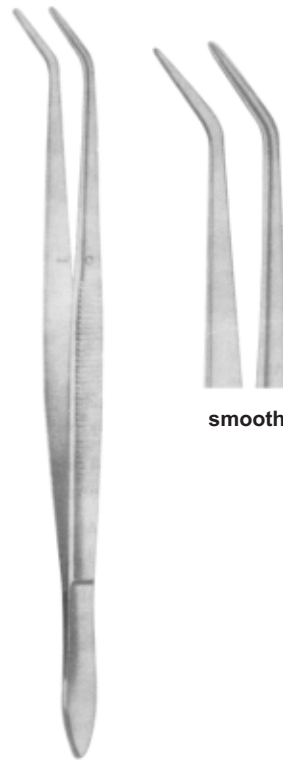

smooth

TS-5-5347
Meriam
16 cm

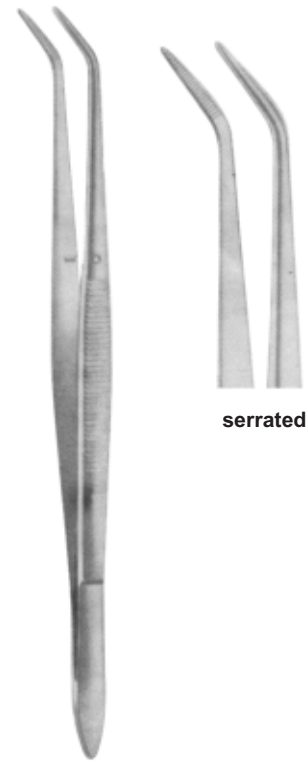

serrated

TS-5-5348
Meriam
16 cm

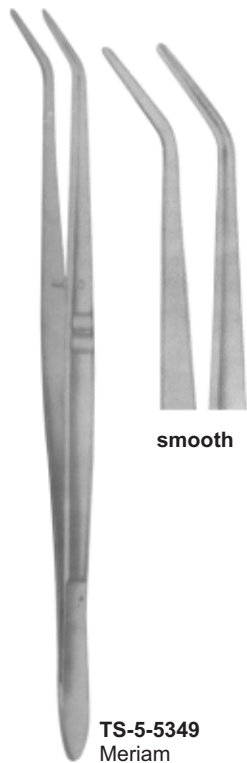

smooth

TS-5-5349
Meriam
16 cm

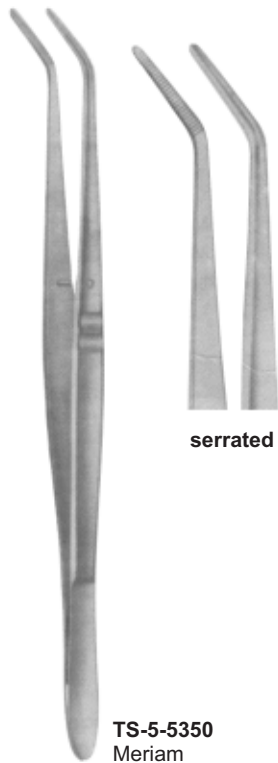

serrated

TS-5-5350
Meriam
16 cm

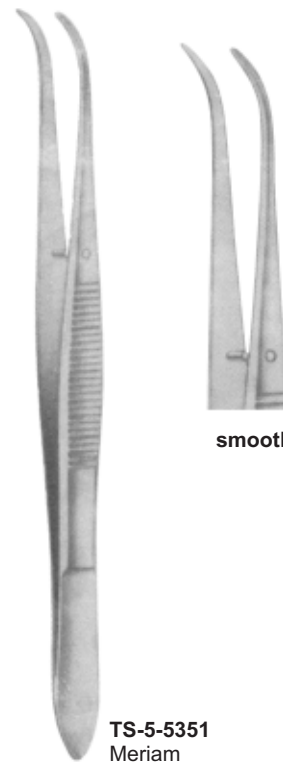

smooth

TS-5-5351
Meriam
16 cm

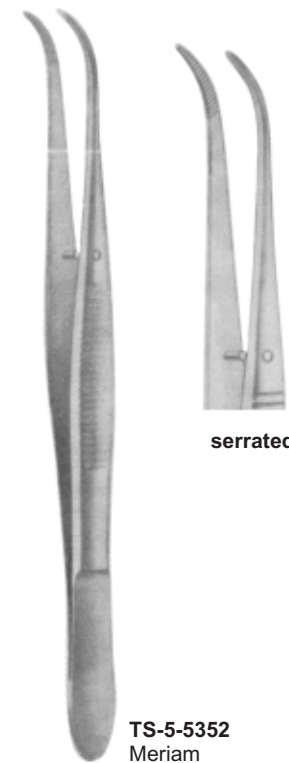

serrated

TS-5-5352
Meriam
16 cm

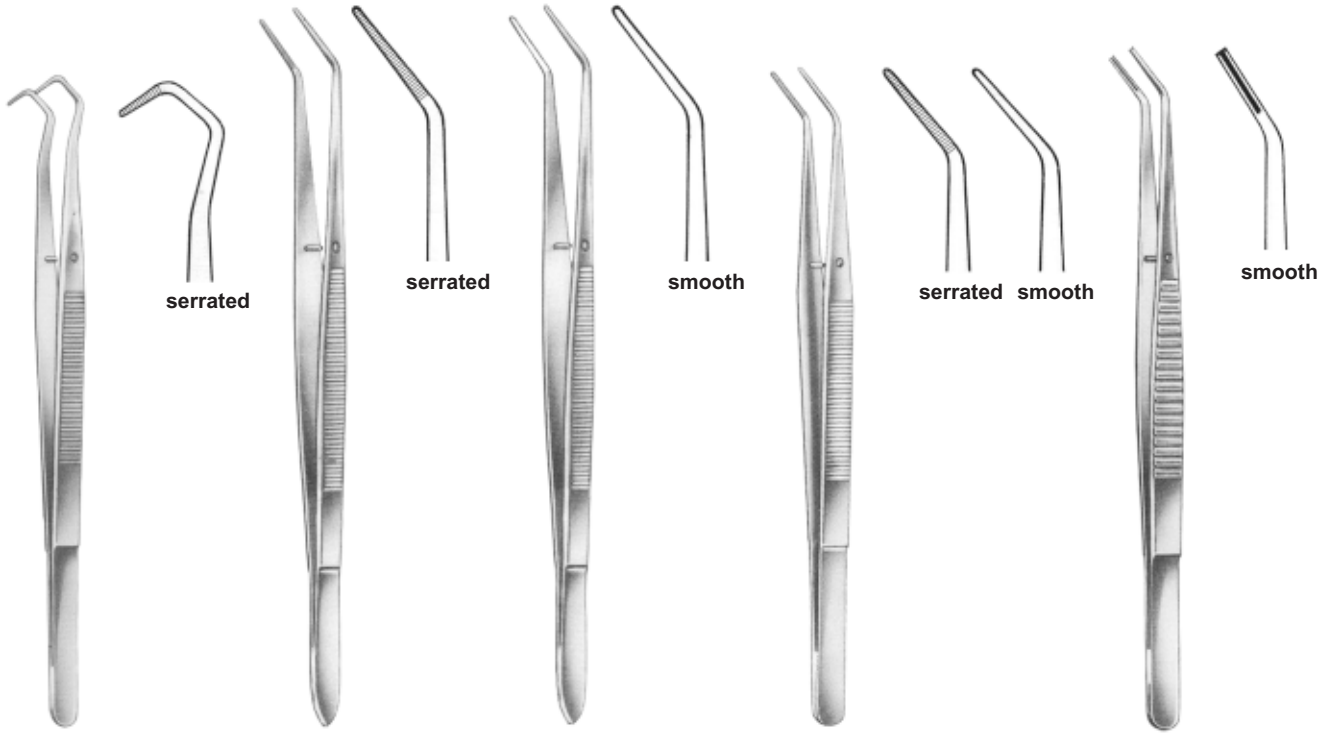

TS-5-5353
College
14.5 cm, 5³/₄"

serrated

TS-5-5354
Flagg
16 cm, 6¹/₄"

serrated

smooth

TS-5-5355
Flagg
16 cm, 6¹/₄"

serrated smooth

smooth

TS-5-5356
Landgraf
15 cm, 6"

TS-5-5357
15,5 cm, 6¹/₈"

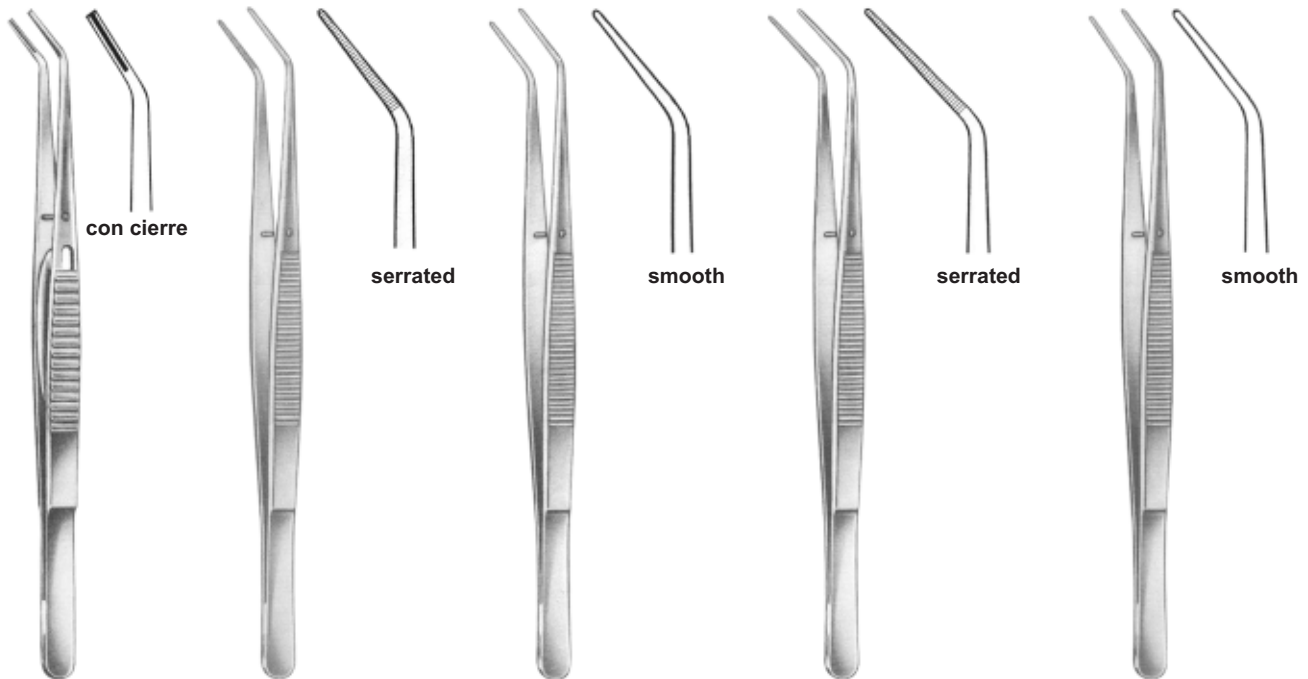

con cierre

serrated

smooth

serrated

smooth

TS-5-5358
15.5 cm, 6¹/₈"

TS-5-5359
London-College
15 cm, 6"

TS-5-5360
London-College
15 cm, 6"

TS-5-5361
London-College
15 cm, 6"

TS-5-5362
London-College
15 cm, 6"



Dental Tweezers



TS-5-5363
CK1
15 cm, 6"

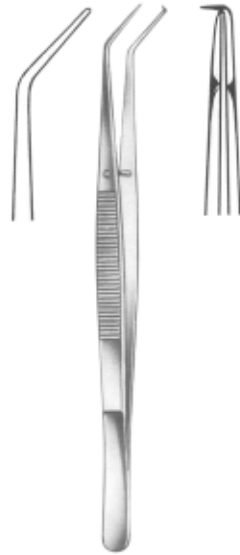

TS-5-5364
CK2
15 cm, 6"

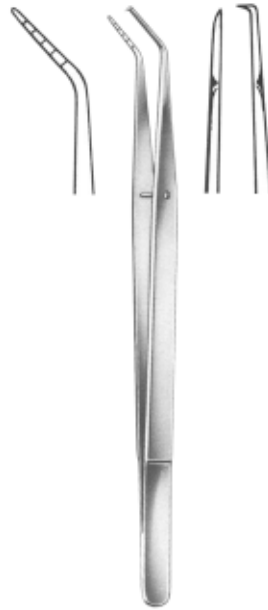

TS-5-5365
GF2
16 cm, 6 1/4"



TS-5-5366
Gf1
16 cm, 6 1/4"

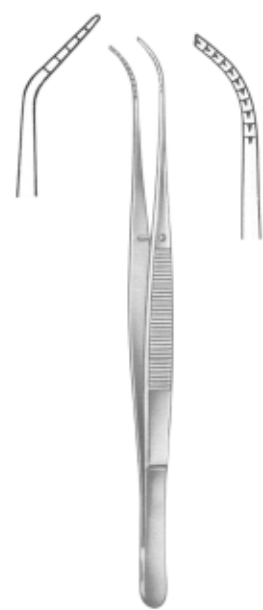

TS-5-5367
Kopp
15.5 cm, 6 1/8"



TS-5-5368
Kopp
15.5 cm, 6 1/8"



TS-5-5369
15 cm, 6"



TS-5-5370
16.5 cm, 6 1/2"



TS-5-5371
15.5 cm, 6 1/8"



TS-5-5372
Kopp
15.5 cm, 6 1/8"



TS-5-5373
London-College
15 cm, 6"

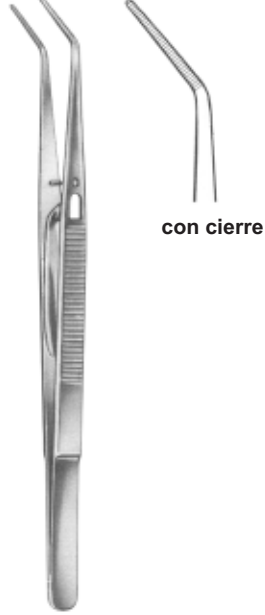

TS-5-5374
London-College
15 cm, 6"

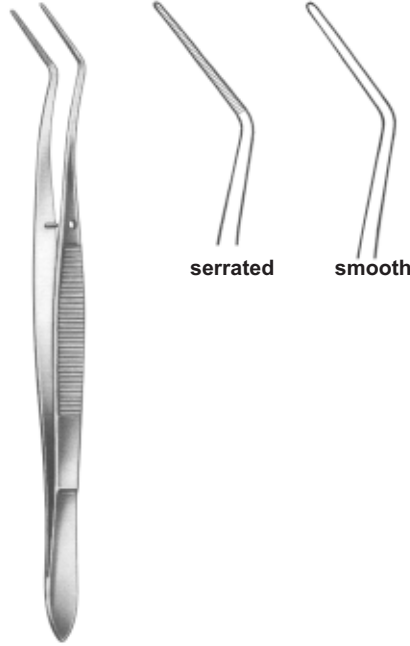

TS-5-5375
Meriam
16 cm, 6 1/4"



TS-5-5376
Allen
18 cm, 7 1/8"



TS-5-5377
Albrecht
16 cm, 6 1/4"

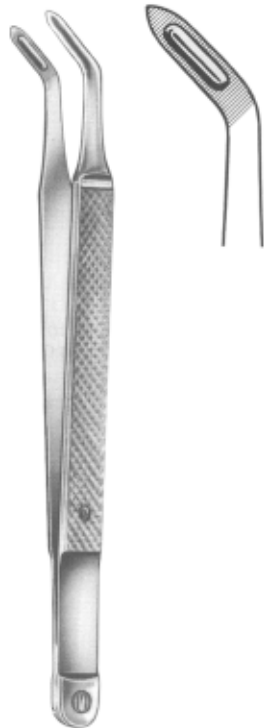

TS-5-5378
Albrecht
16 cm, 6 1/4"



TS-5-5379
16 cm, 6 1/4"



TS-5-5380
16 cm, 6 1/4"

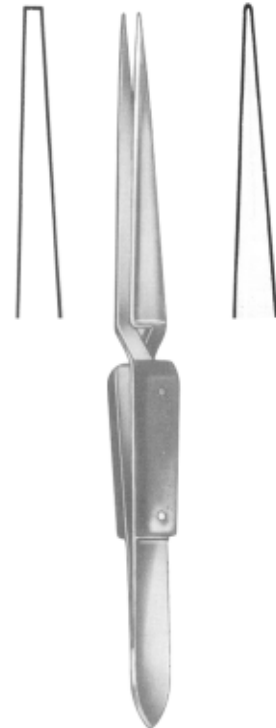

TS-5-5381
16 cm, 6 1/4"



Page
115-117

- Rubber Dam Clamps

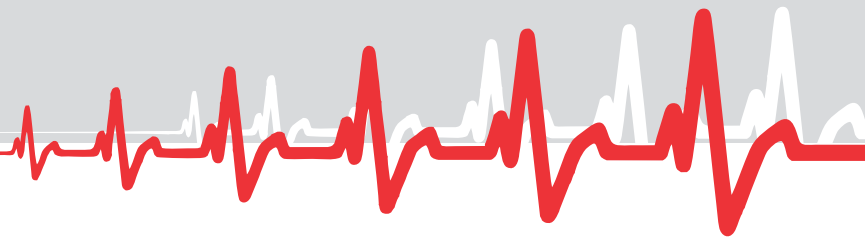



Rubber Dam Clamp Forceps

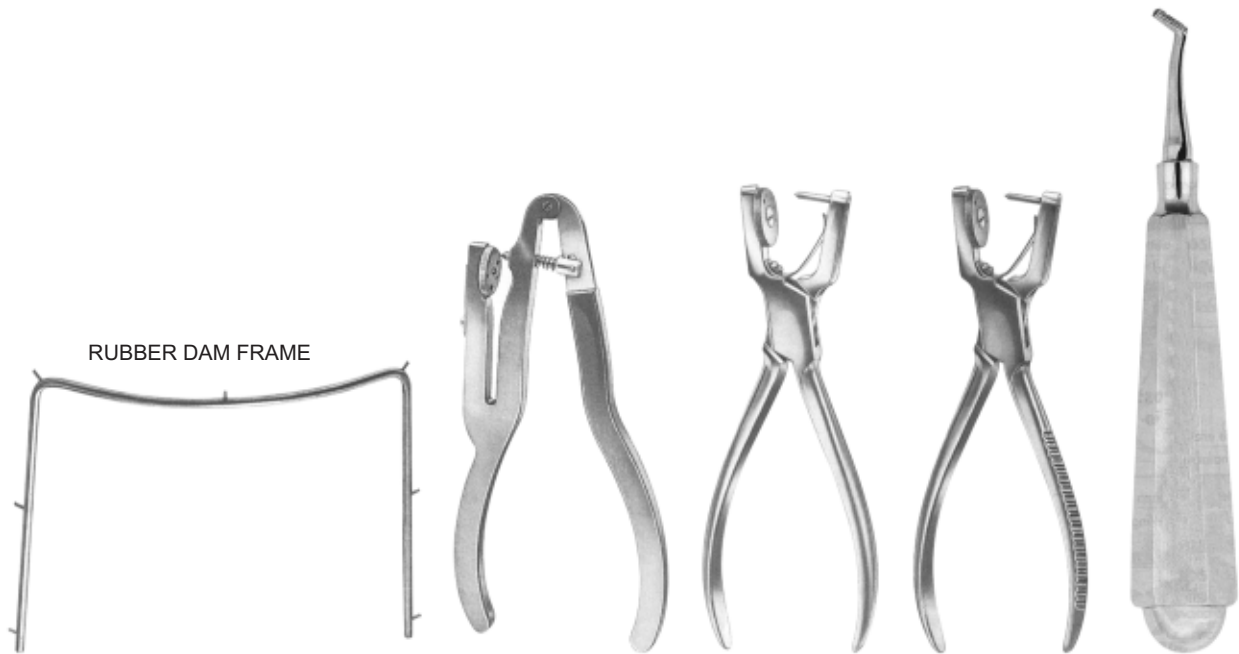

RUBBER DAM FRAME

TS-5-5382
Young
105x95 Inox

TS-5-5383
Ivory
160 mm

TS-5-5384
Ainsworth
170 mm

TS-5-5385
Ainsworth
170 mm

TS-5-5386
Mershan
140 mm

CLAMPS (PLIERS)

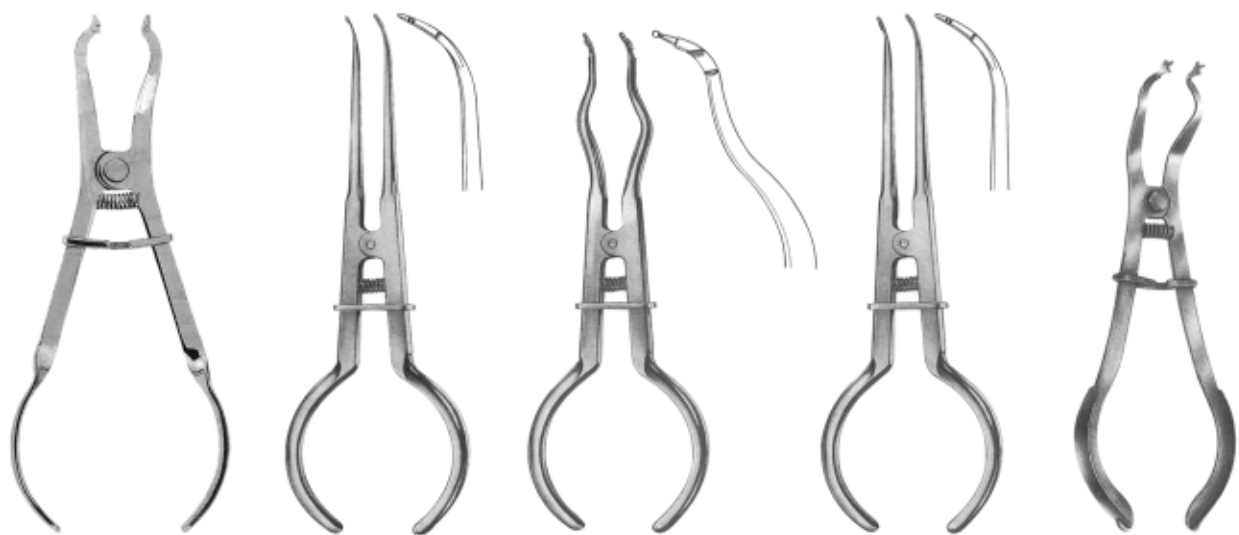

TS-5-5387
Ivory light weight
170 mm

TS-5-5388
Brewer
175 mm

TS-5-5389
Brewer
175 mm

TS-5-5390
White
175 mm

TS-5-5391
Ivory
170 mm



Anterior



TS-5-5392
Winged
Labial Clamp



TS-5-5393
Winged
Edged Labial Clamp



TS-5-5394
Winged
Cervical Clamp



TS-5-5395
Winged
Labial Clamp

Premolars



TS-5-5396
Winged



TS-5-5397
Winged



TS-5-5398
Wingless

For Small Teeth, Elongated or With Narrow Collars



TS-5-5399
Winged



TS-5-5400
Winged



TS-5-5401
Wingless

For General Use With Adjustable Jaws According To Gingival Line Shapes



TS-5-5402
Winged



TS-5-5403
Edged, Winged



TS-5-5404
Wingless

For Premolars, With Elongated Collar



TS-5-5405
Winged



TS-5-5406
Edged, Winged



TS-5-5407
Wingless

For Premolars, With Elongated Collar



TS-5-5408
Wingless



TS-5-5409
Wingless

Rubber Dam Clamps



TS-5-5410
Winged



TS-5-5411
Wingless

For Small Lower Molars



TS-5-5412
Winged



TS-5-5413
Wingless

For Small Lower Molars With Round clamps



TS-5-5414
Winged



TS-5-5415
Wingless

For Square Lower Molars



TS-5-5416
Winged



TS-5-5417
Wingless

For Round Upper Molars



TS-5-5418
Winged



TS-5-5419
Wingless

For Molar Roots



TS-5-5420
Winged



TS-5-5421
Wingless

For Partially Broken Molars



TS-5-5422
Winged



TS-5-5423
Edged Winged



TS-5-5424
Wingless

For Round Molars, Partially Broken, Undersized or Inclined



TS-5-5425
Winged



TS-5-5426
Wingless



TS-5-5427
Wingless



TS-5-5428
Wingless



TS-5-5429
Winged



TS-5-5430
Winged



Page
118-122

- Matrix Retainer
- Matrix Bands

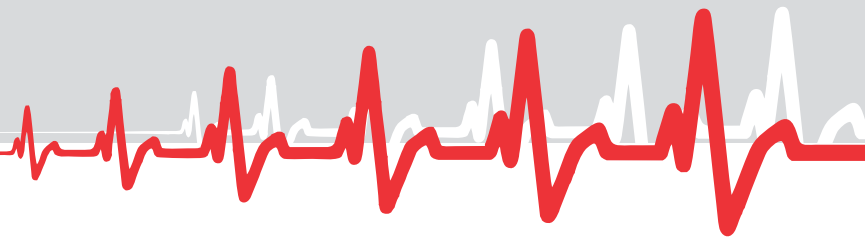

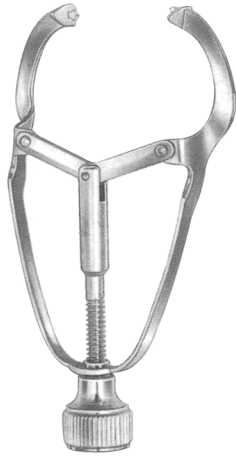

TS-6-5101
Ivory
63mm

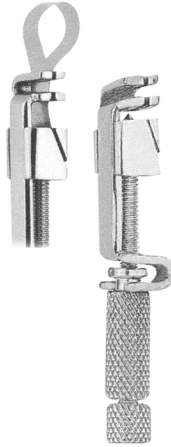

TS-6-5102
Tofflemire-Universal

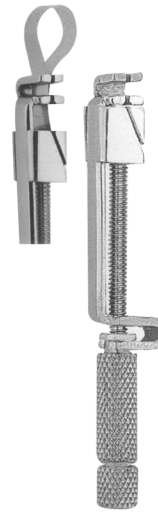

TS-6-5103
Tofflemire-Junior



TS-6-5104
Tofflemire-Senior

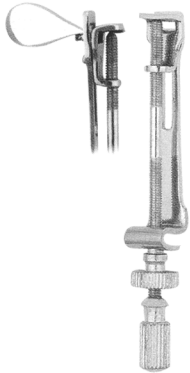

TS-6-5105
Ivory 8
5 mm



TS-6-5106
Ivory 8
6 mm



TS-6-5107
Ivory 8
7 mm



TS-6-5108
Ivory 8 N



TS-6-5109
Didner 8 P



TS-6-5111



TS-6-5112



TS-6-5113

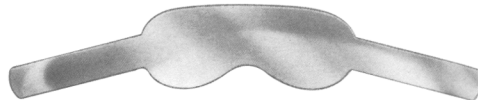

TS-6-5114



TS-6-5110

1750-5 mm x 100 cm
1750-6 mm x 100 cm
1750-7 mm x 100 cm

For Molars and Premolars

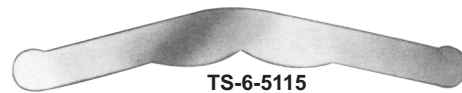

TS-6-5115



TS-6-5116



TS-6-5117



Matrix Bands

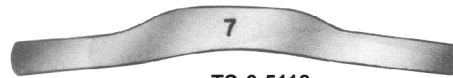

7
TS-6-5118
Molar
Fig 7

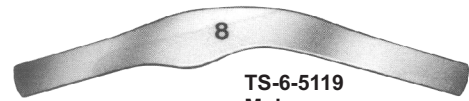

8
TS-6-5119
Molar
Fig 8

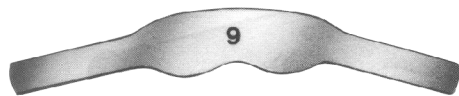

9
TS-6-5120
Molar
Fig 9

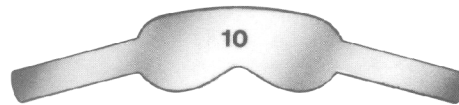

10
TS-6-5121
Molar
Fig 10



1
TS-6-5122
Tofflemire



2
TS-6-5123
Tofflemire



3
TS-6-5124
Tofflemire



11
TS-6-5125
Bicuspid

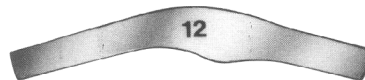

12
TS-6-5126
Bicuspid



13
TS-6-5127
Bicuspid



1
TS-6-5128
Bicuspid



2
TS-6-5129
Bicuspid



3
TS-6-5130
Bicuspid



TS-6-5134

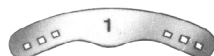

1
TS-6-5131
Molar



2
TS-6-5132
Molar



3
TS-6-5133
Molars



Page
120-122

- Crown Removers
- Scissors
- Forceps
- Amalgum Guns
- Carries

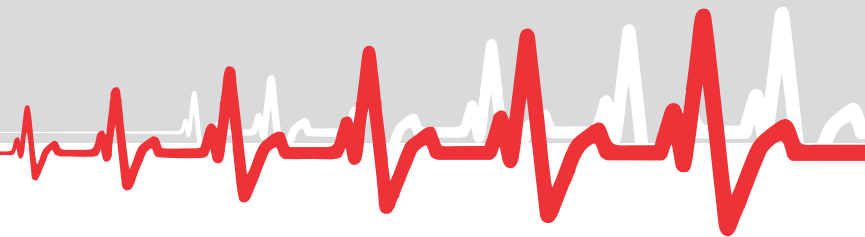

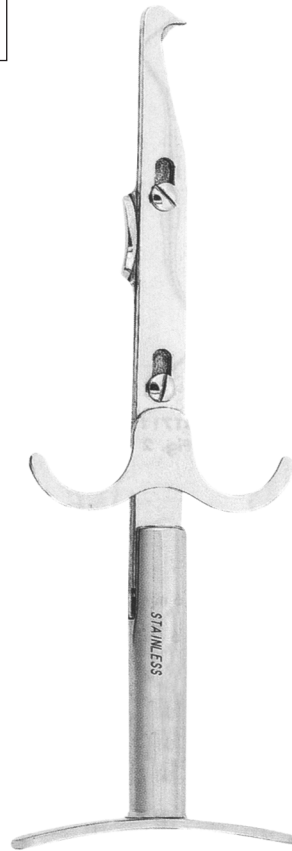
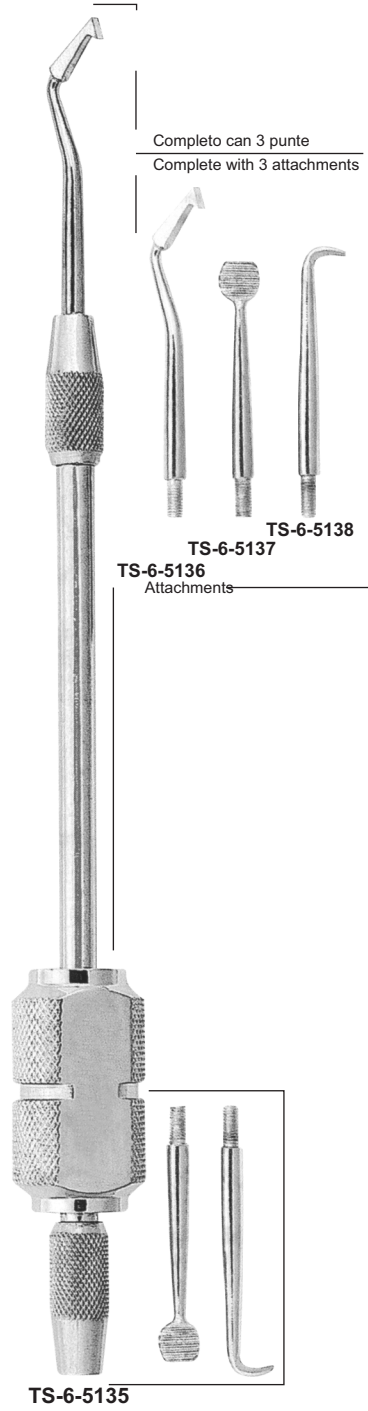

TS-6-5139
Crown Spreader, Crown Remove.
Special instrument for crown spreading
after separating, simple and safe
operation.

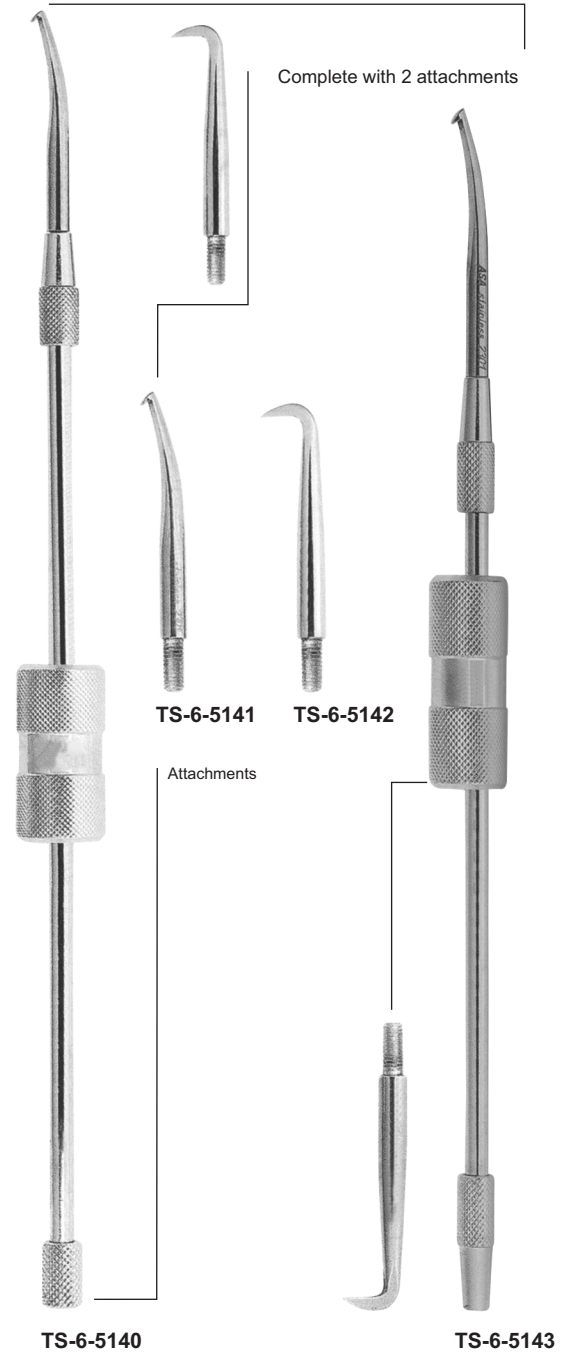



Dental Crown Removers, Scissors, Forceps, Amalgam Guns & Carriers



Universal "HM"
12 cm, 4 3/4"

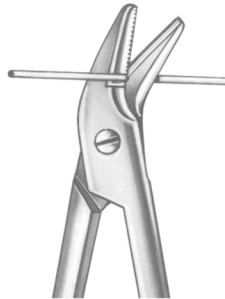

TS-6-5144

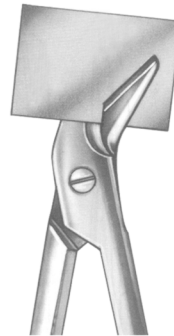

TS-6-5145

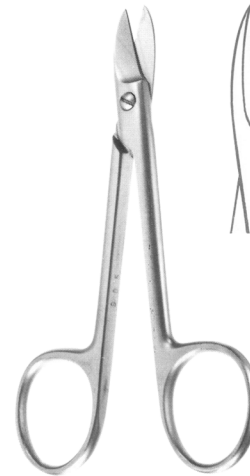

TS-6-5146
Beebee
10,5 cm, 4 1/8"

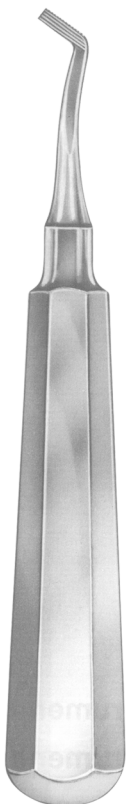

TS-6-5147
Mershon



TS-6-5148
Morell



TS-6-5149
Morell



TS-6-5150
Morell



TS-6-5151
Morell



TS-6-5152
Treymann



TS-6-5153
Automatic Crown Remover
With 2 Points



TS-6-5154



TS-6-5155

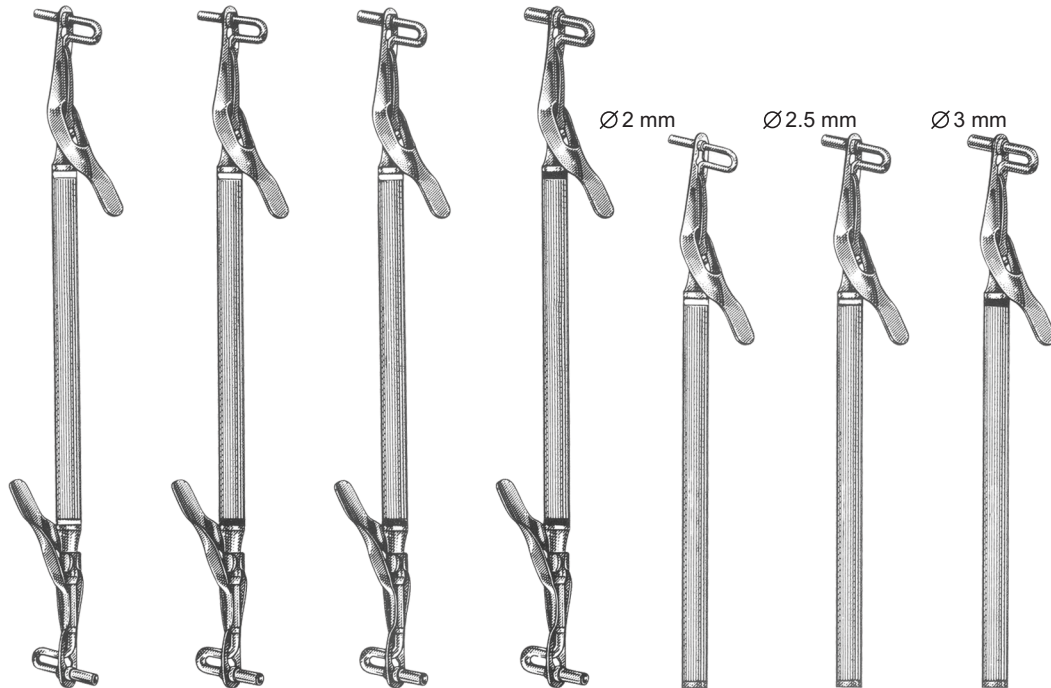

TS-6-5156
Medium-Large
20 cm

TS-6-5157
Medium-Jumbo
20 cm

TS-6-5158
Large-Jumbo
20 cm

TS-6-5159
Jumbo-Jumbo
20 cm

TS-6-5160
Medium
15.5 cm

TS-6-5161
Large
15.5 cm

TS-6-5162
Jumbo
15.5 cm



TS-6-5163
Straight
15 cm

TS-6-5164
15 cm

TS-6-5165
15 cm

TS-6-5166
Amalgam Well
Non Skid Base
Ø3.5 mm

90°



Page
123

- Copper Ring Removing Plierspaper Articulator Forceps

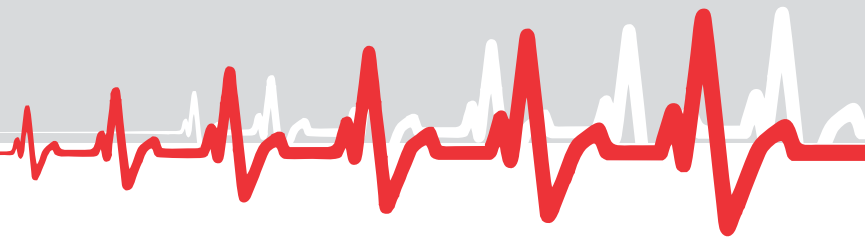



Copper Ring Removing Pliers, Paper Articulator Forceps

Copper ring removing pliers



TS-6-5167
Bohm
11,5 cm



TS-6-5168
Bohm
14,5 cm



TS-6-5169
Furrer
16 cm



TS-6-5170
Furrer
16 cm



TS-6-5171
Miller
15 cm



TS-6-5172
Miller
15 cm



TS-6-5173
Kelly
14 cm



TS-6-5174
Halstead-Mosquito
12 cm



TS-6-5175
Micro-Mosquito
10 cm



Page
124-127

- Rongeurs

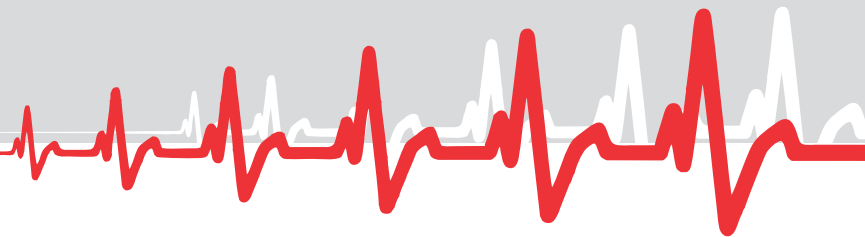

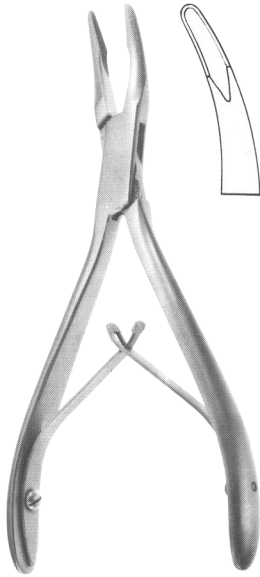

TS-6-5176
Friedmann
14 cm, 5 1/2"

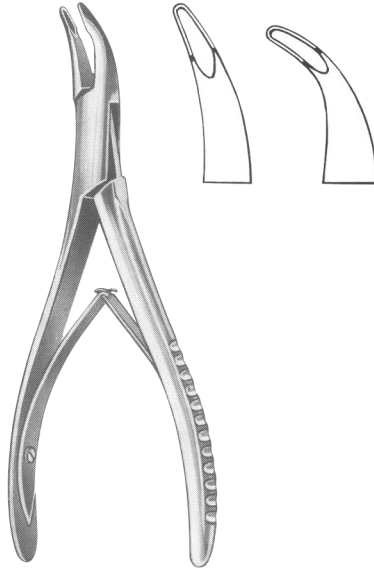

TS-6-5177
14 cm, 5 1/2"

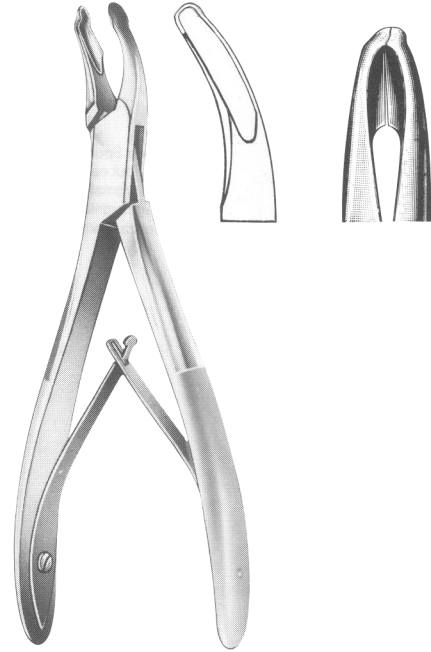

TS-6-5178
Mead
14 cm, 5 1/2"

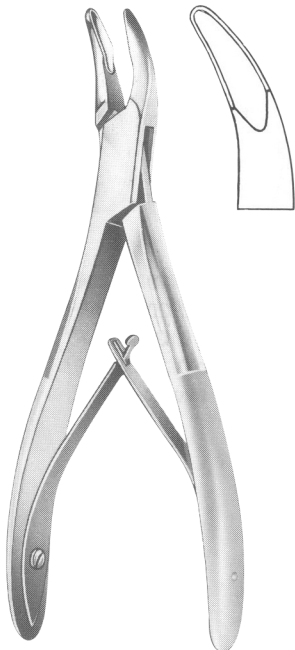

TS-6-5179
Mead
14 cm, 5 1/2"



TS-6-5180
Mead
17 cm, 6 3/4"

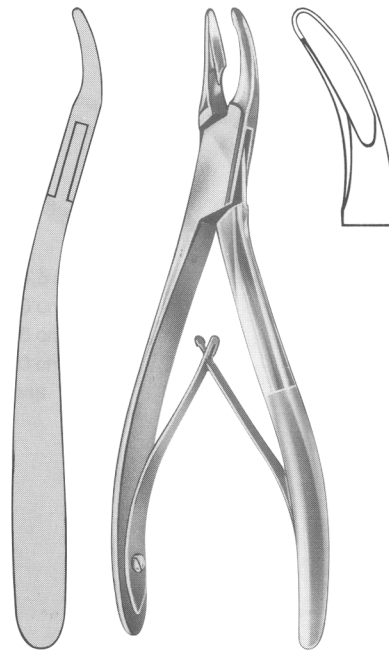

TS-6-5181
Schell
17 cm, 6 3/4"



TS-6-5182
Luer
15 cm



TS-6-5183
Friedman
14 cm



TS-6-5184
Mini Friedman
12 cm



TS-6-5185
Goldman-Fax
10 cm



TS-6-5186
Blumenthal
15 cm



TS-6-5187
Blumenthal 45
14,5 cm



TS-6-5188
Blumenthal 90
14 cm



TS-6-5189
Bohler
15 cm



TS-6-5190
Kerrison
15 cm

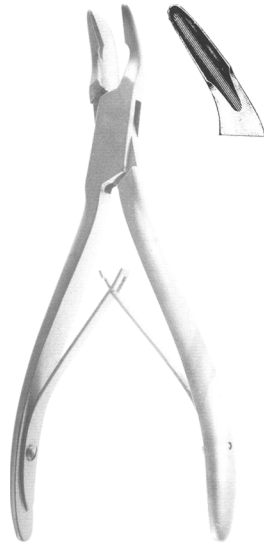

TS-6-5191
Blumenthal
16 cm, 6 1/4"

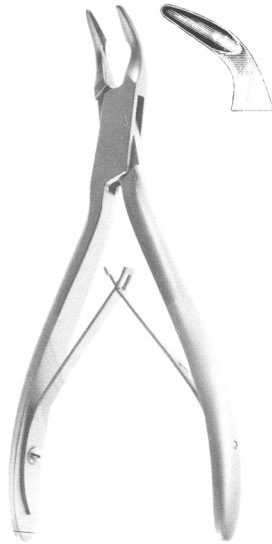

TS-6-5192
Blumenthal
16 cm, 6 1/4"

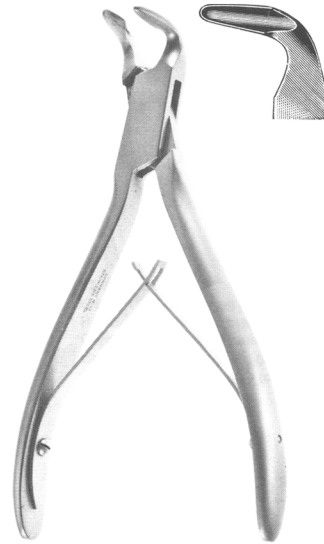

TS-6-5193
Blumenthal
16 cm, 6 1/4"

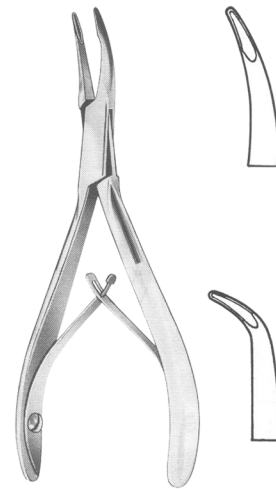

TS-6-5194
Kleinert-Kutz
14 cm, 5 1/2"



TS-6-5195
Ruskin-Mini
15 cm

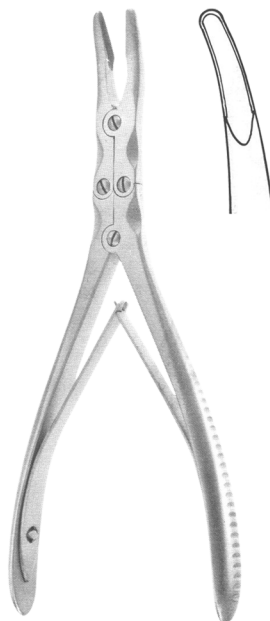
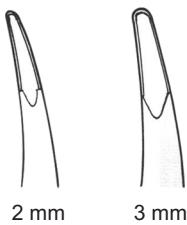

TS-6-5196
Beyer
18 cm, 7 1/8"



TS-6-5197
Zaufal-Jansen
18 cm, 7 1/8"

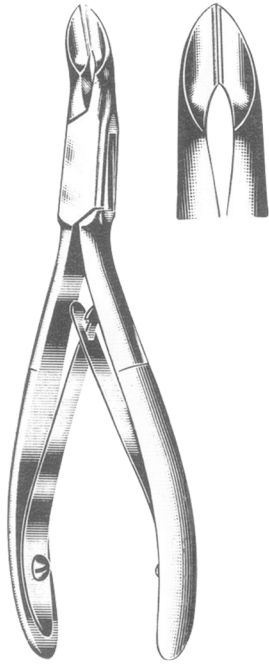

TS-6-5198
Niro
No. 5 S, 14 cm, 5 1/2"

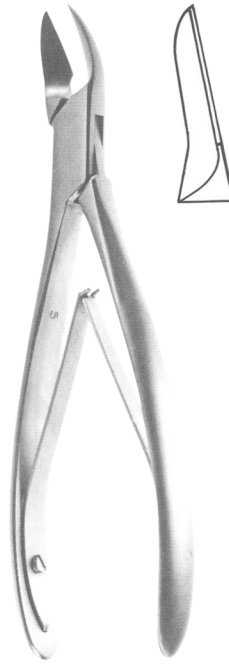

TS-6-5199
Cleveland
No. 5 S, 17 cm, 6 3/4"

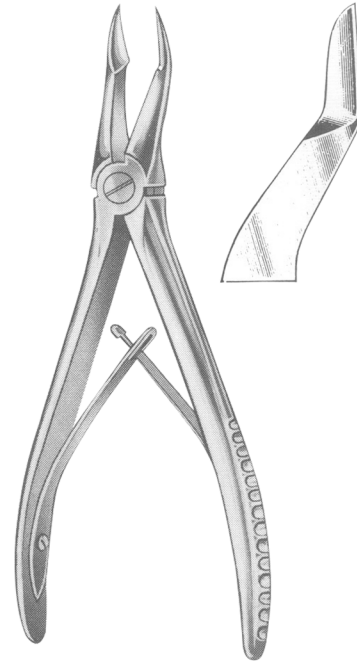

TS-6-5200
No. 18, 15 cm, 6"

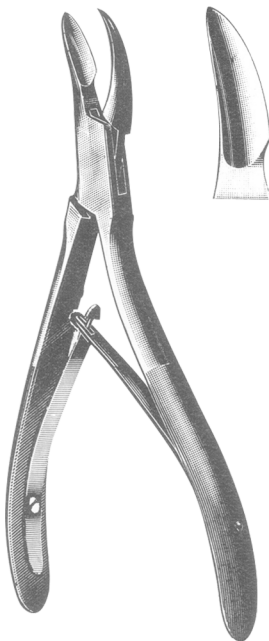

TS-6-5201
Cleveland
16 cm, 6 1/4"



TS-6-5202
Gardner
16 cm, 6 1/4"



TS-6-5203
Liston-mini
15 cm, 6"



Page
128-129

- Bone Elevators, Bone Files and Chisels

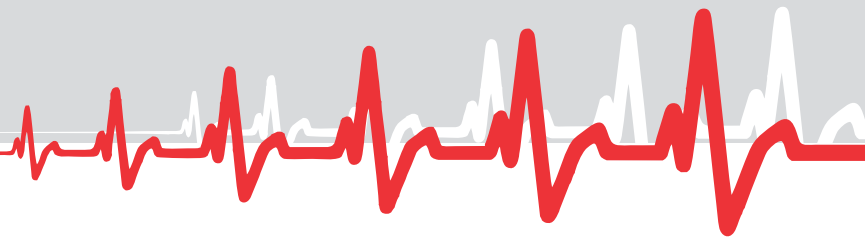

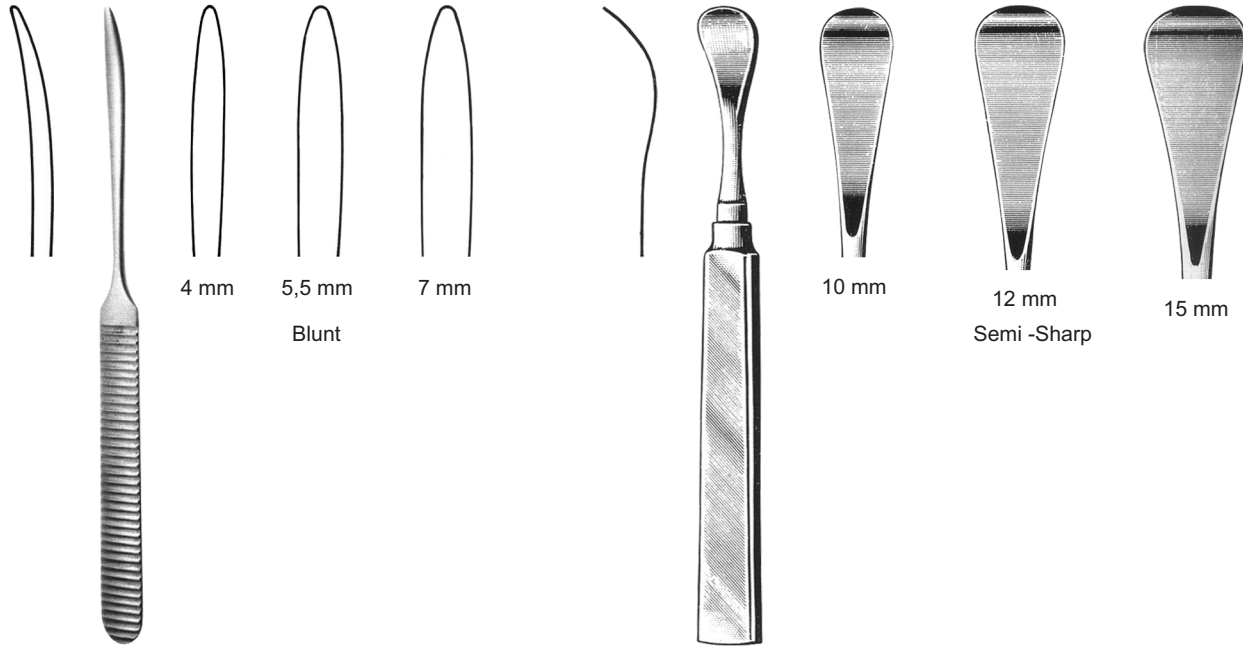

TS-6-5204
Williger
16 cm, 6 1/4"

TS-6-5205
Henahan
17 cm, 6 3/4"

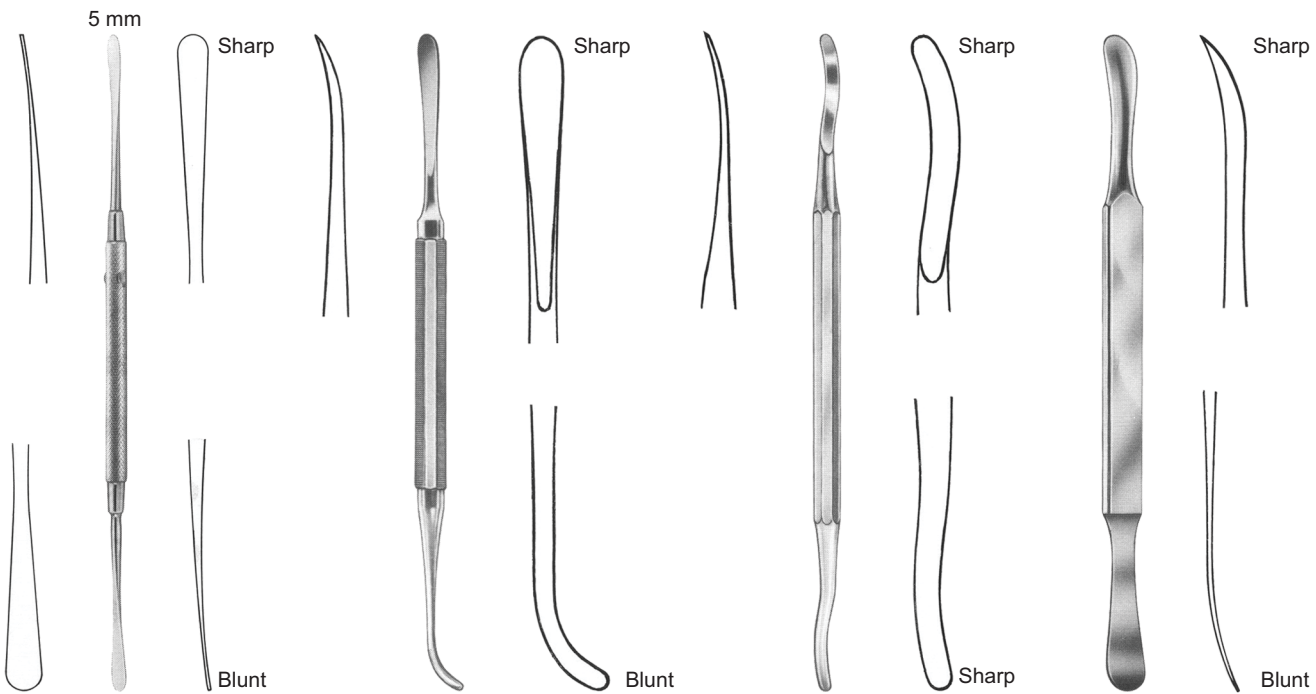

TS-6-5206
Freer
19 cm, 7 1/2"

TS-6-5207
Bennet
17 cm, 6 3/4"

TS-6-5208
Seldin
19 cm, 7 1/2"

TS-6-5209
Seldin
19,5 cm, 7 3/4"



Bone Files and Chisels



Buckley
15 cm, 6"

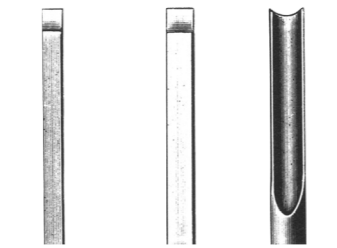

TS-6-5210 No. 1 3mm
TS-6-5211 No. 2 4mm
TS-6-5212 No. 3 5mm

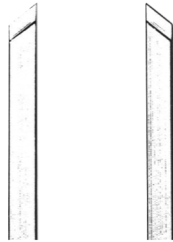

TS-6-5213 No. 4 4mm
TS-6-5214 No. 5 4mm



TS-6-5215
Killian
16 cm, 6 1/4" 5 mm



TS-6-5216
Killian-Claus
16 cm, 6 1/4" 5 mm

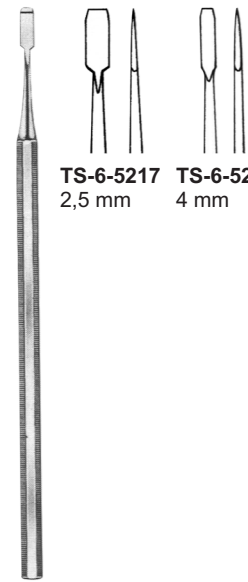

Obwegeser

TS-6-5217 2,5 mm
TS-6-5218 4 mm



TS-6-5219
Miller
No.10C



TS-6-5220
Miller
No.11C

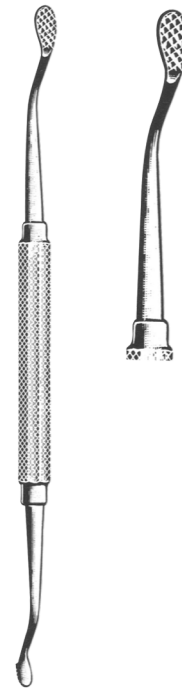

TS-6-5221
Miller
No.12C

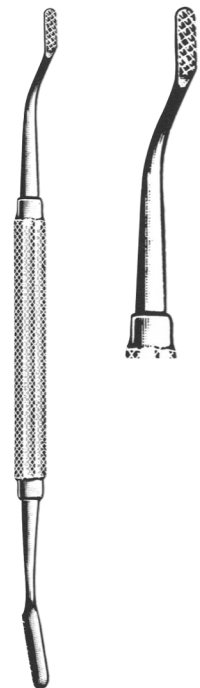

TS-6-5222
Miller
No.13C



Page 130-151

- Pliers For Orthodontics
- Mouth Gags
- Tongue Depressors
- Lip and Cheek Retractors
- Implantology Instrumetns

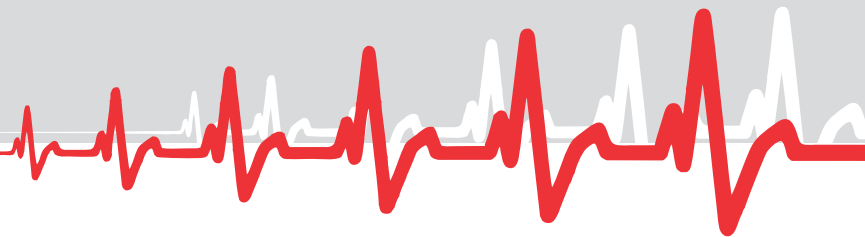



Pinze per formare loops
Loops forming pliers



TS-7-5101
Adams

Adams pliers for bending
wieses up to 0,7mm. (.28").

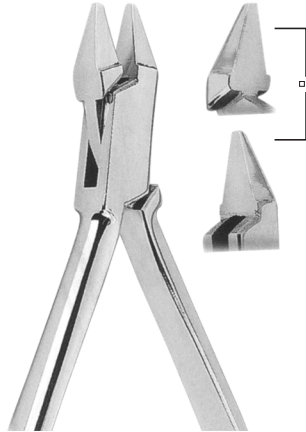

TS-7-5102
Adams

Adams pliers for bending
wieses up to 0,7mm. (.28").

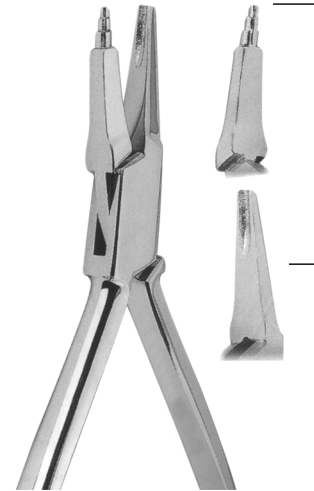

TS-7-5103
Adams

Tweed loop forming pliers.
For forming loop in wires up
to 0,56 mm. (.22").



TS-7-5104
Adams

Aderer three jaws bending
pliers. For wires up
to 0,7 mm. (.28").



TS-7-5105
Adams

Aderer three jaws bending
pliers. For wires upto 0,7 mm.
(.28").



Pliers for Othodontics

Ligature Cutter Pliers



TS-7-5106

Micro-miniature light wire cutter. It cuts soft ligature wires. For use in caso of limited access. Caution: maximum cutting capacity: soft ligature wire up to 0,30 mm. (.012").



TS-7-5107

Wire cutter. For ligature wires and pins. It is strong enough to bend archwire ends after distal cutting. Maximum cutting capacity up to 0,56 x 0,7 mm. (.022" x .028").

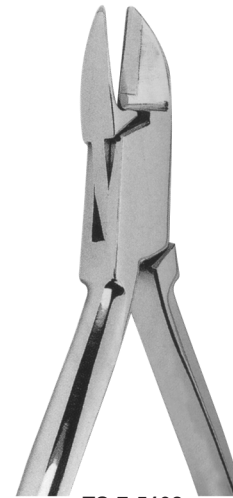

TS-7-5108

Wire cutter. For ligature wires and pins. It is strong enough to bend archwire ends after distal cutting. Maximum cutting capacity: up to 0,9 mm. (.036").



TS-7-5109

Wire cutter. For ligature wires and pins. It is strong enough to bend archwire ends after distal cutting. Maximum cutting capacity: up to 1,5 mm. (.044").



Pinze per formare laboratorio
Laboratory pliers



TS-7-5110

Flat nose pliers with smooth beaks for bending wires up to 0,7 mm. (.028").



TS-7-5111

Bending wires up to 0,7 mm. (.028").



TS-7-5112

Bending wires up to 0,7 mm. (.028").



TS-7-5113

Bending wires up to 0,7 mm. (.028").



Pliers for Othodontics



TS-7-5114
Nance

Nance loop closing pliers, for bending of stop loops and special for Adams' clasps. Wires up to 0,7 mm. (.028").



TS-7-5115
Nance

Universal pliers for bending wires up to 0,9 mm. (.035") or cutting up to 0,7 mm. (.028").

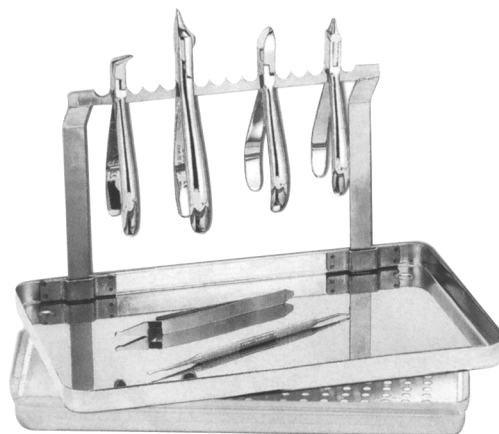

TS-7-5116

Stainless steel pliers tray standard dimensions



TS-7-5117
Universal

Universal pin roughening, cutting and bending pliers. For wires up to 0,9 mm. (.035"). Will cut wires up to 0,7 mm. (.028").



Utility and specialty pliers



TS-7-5118
Reynolds

Reynolds contouring pliers.



TS-7-5119
Reynolds

Lingual arch pliers used to form double and triple back bends in 0,7 mm. (.028") or 0,9 mm. (.035") wire for insertion in lingual sheaths.



TS-7-5120
Weingart

Weingart pliers with serrated points.

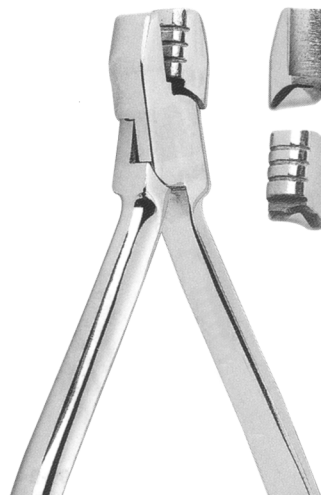

TS-7-5121
De La Rosa

De La Rosa arch forming pliers. Designed to form and contour arch wires on round or rectangular wire. The beak has grooves of 0,4 mm (.016"), 0,46 mm (.018") and 0,56 mm (.022").



TS-7-5122
De La Rosa

Arch forming pliers with a non grooved contouring surface the forming of precise arches.



Loop formare pliers



TS-7-5123
Waldsachs

Waldsachs universal pliers for bending wires up to 1,0 mm. (.039") or cutting up to 0,7 mm. (.028").



TS-7-5124

Round and Concave pliers for loop forming and bending of thin round and square wires up to 0,5 mm. (.020").

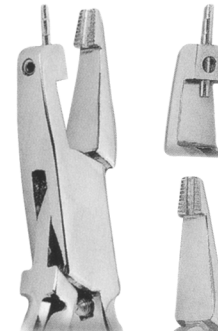

TS-7-5125
Tweed

Tweed loop Forming Pliers. For round or rectangular wires up to 0,56 x 0,7 mm. (.022" x .028"). Replaceable cylindrical beak with three sizes: 1,15 mm. (.045), 1,50 mm. (.059"), 1,90 mm. (.075"). Concave beak with slight parallel serrations, to keep the wire in proper position.

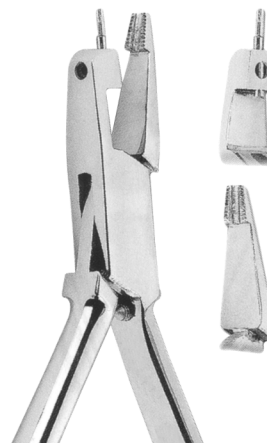

TS-7-5126
Tweed

Tweed Loop Forming Pliers. For making perfect Omega Loops with round or rectangular wires up to 0,56 x 0,7 mm. (.022" x .028"). The concave beak is exactly the same as pliers 5809-1

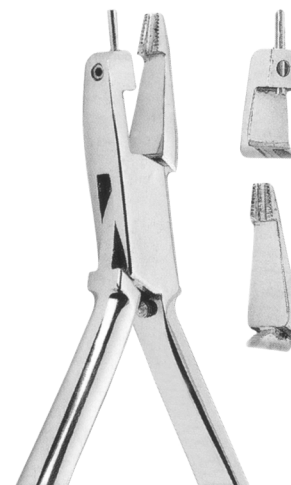

TS-7-5127
Tweed

Single diameter loop forming pliers. Wire up to 0,56 x 0,7 mm. (.022" x 0.28"). Replaceable concave beak has only one diameter section of 1,50 mm. (.059").



Distal end cutters



TS-7-5128

Distal end cutter -safety hold- a precision cutter designed for distal arch cutting in the patient's mouth. It cuts hard wires end holds the loose distal end preventing any damaging of oral tissue. Maximum cutting capacity rectangular wires up to 0,56 x 0,7 mm. (.022" x .020").



TS-7-5129

Micro- distal end cutter - safety hold-. Similar to 3227



TS-7-5130

Direct bonding bracket remover (wide). The removal grip firmly for easy incisal-gingival (vertical) use or, if needed, for mesial-distal (horizontal) use with the same ease.

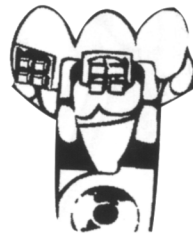

TS-7-5131

Direct bond attachment remover (angled). For removing all bonded attachments. May be used mesial-distal-horizontal) or incisal-gingival (vertical) in anterior areas. Angled perfectly for easy access to difficult posterior areas.



Bird beak pliers



TS-7-5132

Wire bending pliers. For wires up to 0,9 mm. (.036").

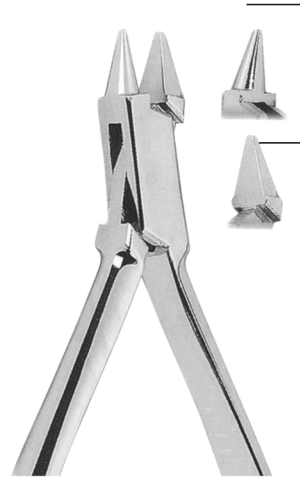

TS-7-5133

Bird Beak Angle pliers for bending round, square or rectangular wire up to 0,7 mm. (.028").



TS-7-5134

Double rounded jaw wire bending pliers. For wires up to 0,7 mm. (.028").



TS-7-5135

Bird beak pliers for bending round, square or rectangular wire up to 0,7 mm. (.028"). With cutter.

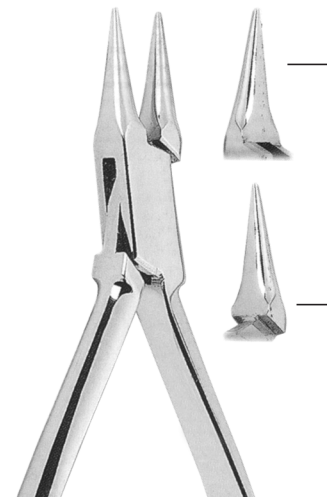

TS-7-5136

Double rounded jaw wire bending pliers. For wires up to 0,7 mm. (.028").



TS-7-5137
USA Model
125 mm



TS-7-5138
Waldron
125 mm



TS-7-5139
How
140 mm

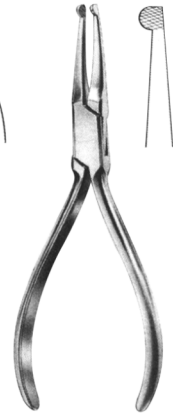

TS-7-5140
How
145 mm



TS-7-5141
Adams
125 mm



TS-7-5142
Angle
125 mm



TS-7-5143
young
130 mm



TS-7-5144
Nance
130 mm



TS-7-5145
Weingart
140 mm



TS-7-5146
Johnson
130 mm



TS-7-5147
Mc Kellops
155 mm

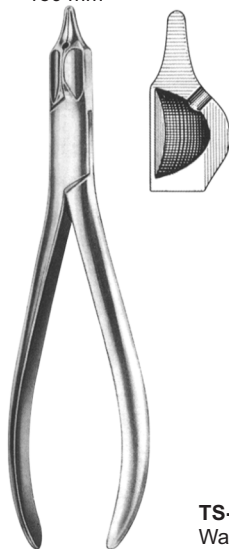

TS-7-5148
Universal
150 mm

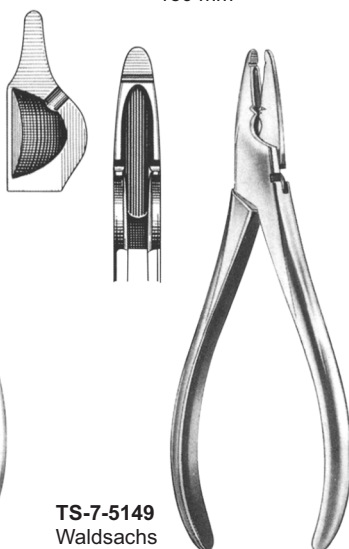

TS-7-5149
Waldsachs
155 mm

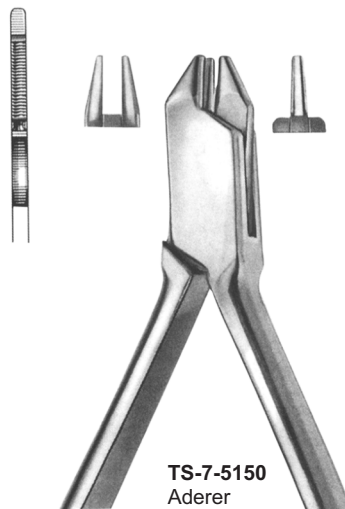

TS-7-5150
Aderer
125 mm



TS-7-5151
Nance
130 mm



Pliers for Othodontics and Prosthetics



TS-7-5152
Langenbeck
140 mm



TS-7-5153
Langenbeck
130 mm



TS-7-5154
Langenbeck
130 mm



TS-7-5155
Peeso
125 mm



TS-7-5156
Goslee
125 mm

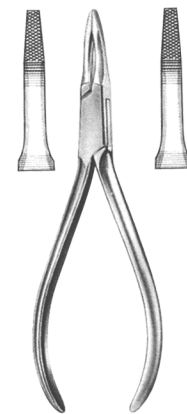

TS-7-5157
Fischer
140 mm

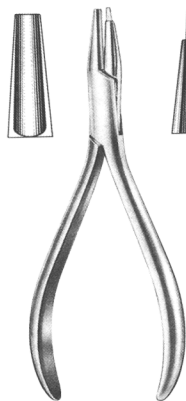

TS-7-5158
Andresen
130 mm

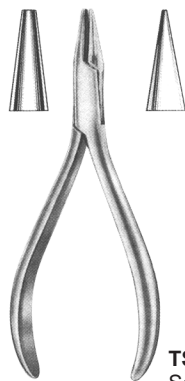

TS-7-5159
Schwarz
130 mm

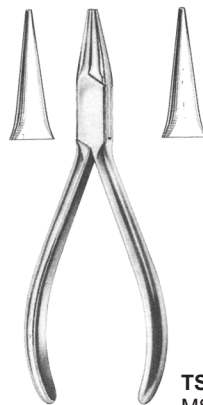

TS-7-5160
MSY
130 mm

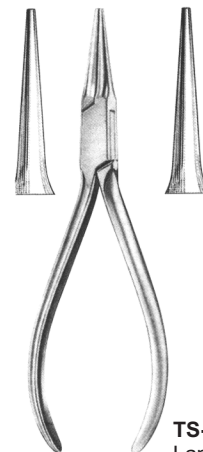

TS-7-5161
Langenbeck
125 mm



TS-7-5162

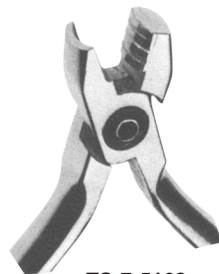

TS-7-5163

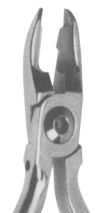

TS-7-5164



TS-7-5165



TS-7-5166



TS-7-5167



TS-7-5168



TS-7-5169

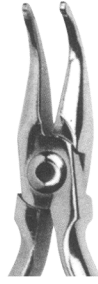

TS-7-5170

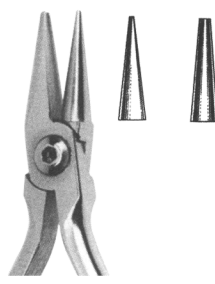

TS-7-5171

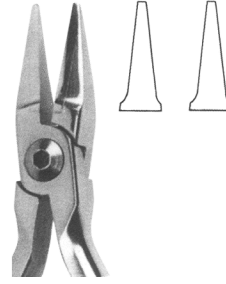

TS-7-5172

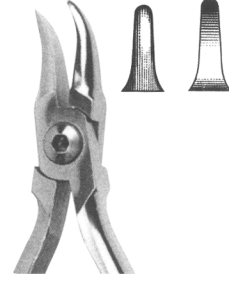

TS-7-5173

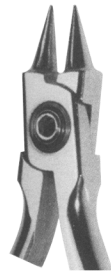

TS-7-5174

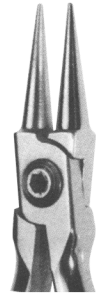

TS-7-5175

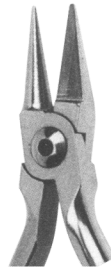

TS-7-5176

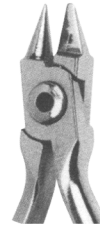

TS-7-5177



TS-7-5178

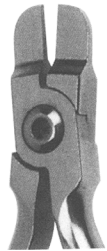

TS-7-5179

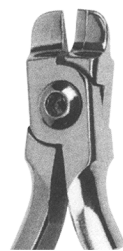

TS-7-5180



TS-7-5181

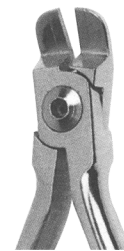

TS-7-5182

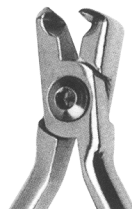

TS-7-5183

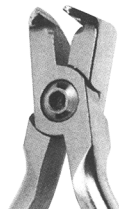

TS-7-5184

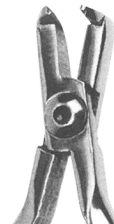

TS-7-5185

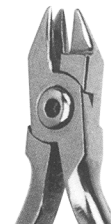

TS-7-5186

Mouth Gags



Molt
TS-7-5187 10 cm
TS-7-5188 11 cm
TS-7-5189 14 cm



TS-7-5190 16 cm
TS-7-5191 19 cm
 Roser-König



TS-7-5192
 Denhardt
 13 cm



TS-7-5193
 Fergusson - Ackland
 14.5 cm



TS-7-5194
 Heister
 Maunder Wood
 9.5 cm



TS-7-5195
 Obwegeser 11 cm
 Spreading 47 mm



TS-7-5196
 Heister
 13 cm



TS-7-5197 Small
TS-7-5198 Medium
TS-7-5199 Large
 Cheek Retractor

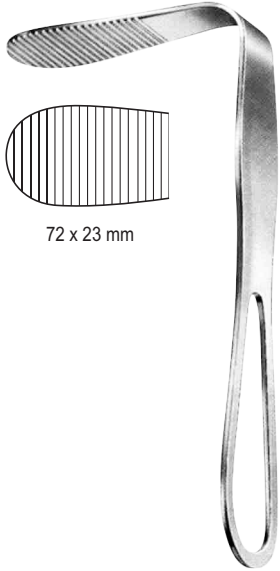

72 x 23 mm

TS-7-5200
Hartmann
15 cm



TS-7-5201
Doyen Tongue Spatula
13.5 cm



TS-7-5202
14.5 cm



TS-7-5203
18 cm



TS-7-5204
Bruenings
19 cm

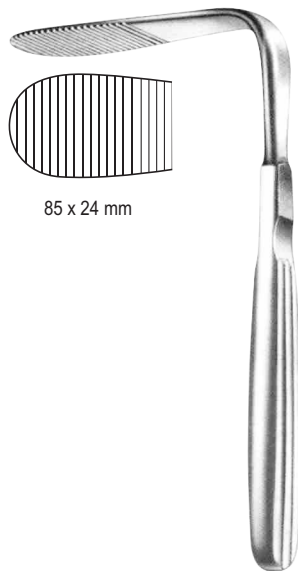

85 x 24 mm

TS-7-5205
Tobold
15 cm

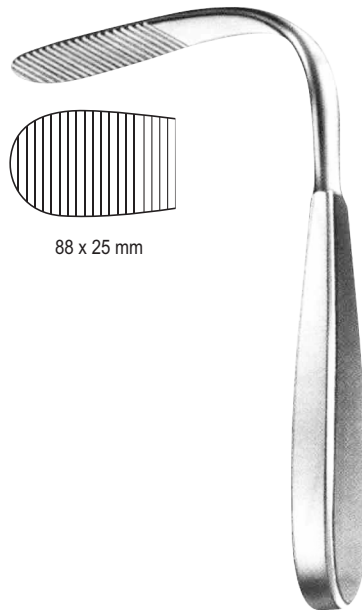

88 x 25 mm

TS-7-5206
Tobold
16 cm

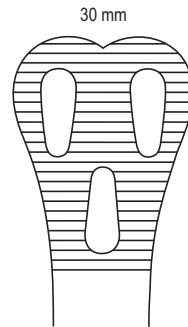

TS-7-5207
14 cm

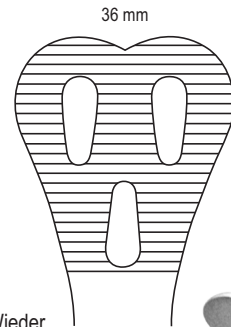

Wieder

TS-7-5208
15 cm

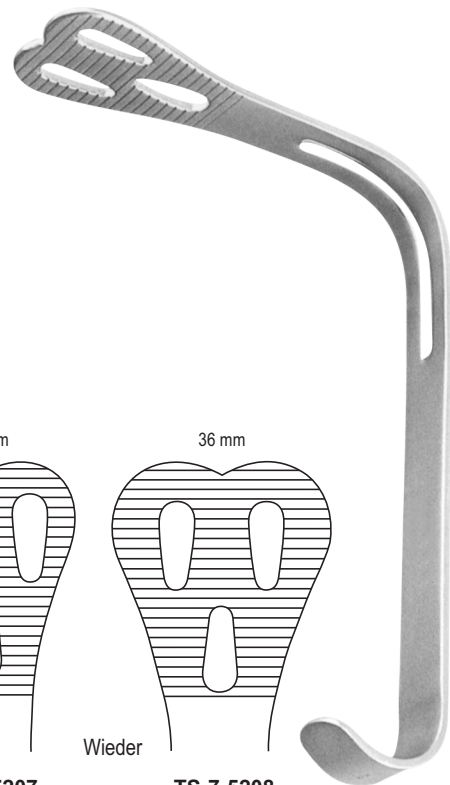

Lip and Cheek Retractors

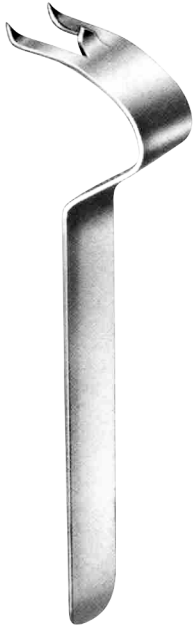

TS-7-5209
Obwegeser Chin
Retractor
16.5 cm



Obwegeser 16 cm
TS-7-5210 8 mm
TS-7-5211 10 mm



TS-7-5212 43 x 11 mm
TS-7-5213 57 x 11 mm
TS-7-5214 83 x 16 mm

35 x 11 mm



TS-7-5215
Obwegeser
Spina-nasalis retractor
22 cm

72 x 11 mm



TS-7-5216
Obwegeser
Ramus retractor for
separation of ramus & tissue
22 cm



TS-7-5217
Simplex
10.5 cm

30x19 mm

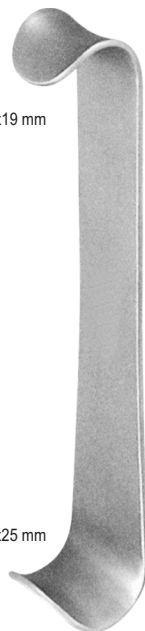

33x25 mm

TS-7-5218
Kilner
15 cm



TS-7-5219
Minnesota
14 cm



TS-7-5220
Cawood-Minnesota
15 cm



TS-7-5221
Austin



TS-7-5222
Hilger
Fits any simple stem mouth mirror handle



TS-7-5223
Hilger
with handle

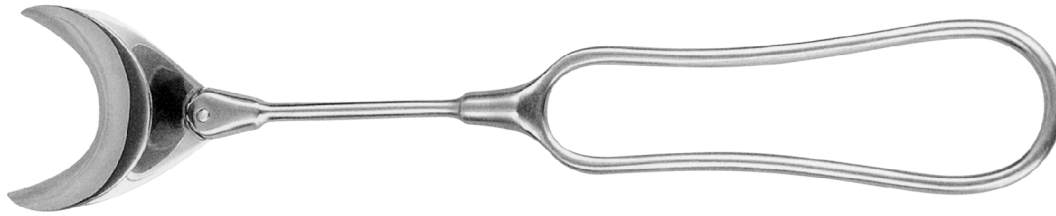

TS-7-5224
Max
20 cm

Finger protectors



Langenbeck

TS-7-5225 Small
TS-7-5226 Medium
TS-7-5227 Large

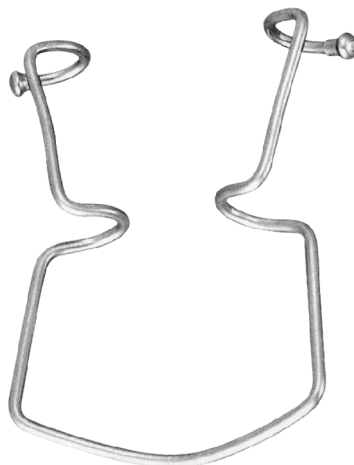

TS-7-5228
Oringer
11.5 cm

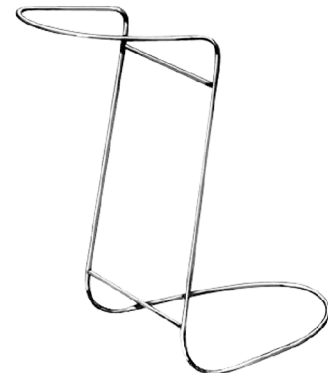

TS-7-5229
Obwegeser Cheek Retractor
12cm

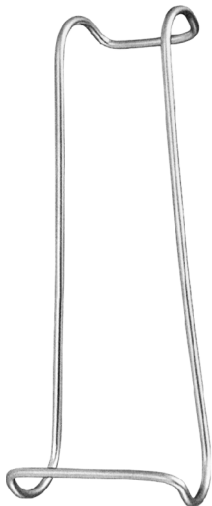

TS-7-5230
Columbia
14.5 cm



Sternberg

TS-7-5231 12 cm
TS-7-5232 14 cm
TS-7-5233 15 cm



Vestibulum
TS-7-5234



TS-7-5235
Max

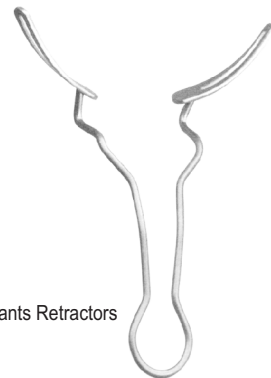

Implants Retractors

TS-7-5236
Max



Retractors

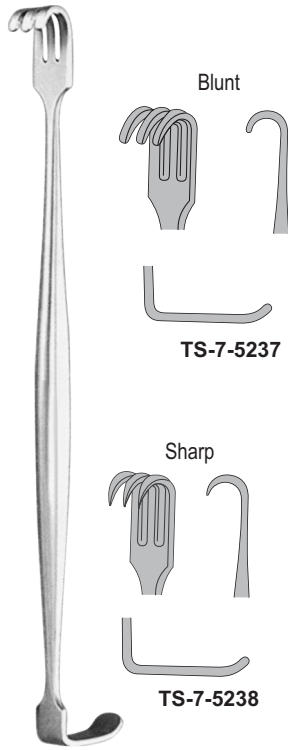

Senn-Miller
16 cm

Blunt

TS-7-5237

Sharp

TS-7-5238

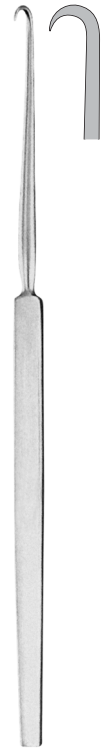

Max
16 cm

Sharp

TS-7-5239

TS-7-5240

TS-7-5241

TS-7-5242

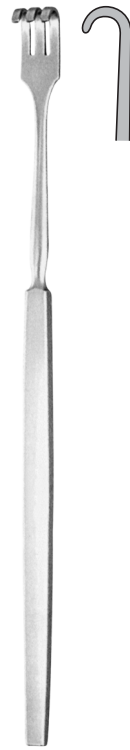

Max
16 cm

Blunt

TS-7-5243

TS-7-5244

TS-7-5245

TS-7-5246

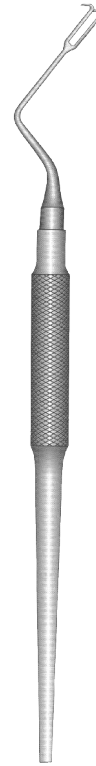

Kirkland
Gum & Tissue
Retractors

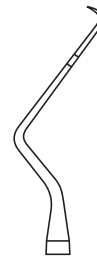

TS-7-5247
Fig. 23 K

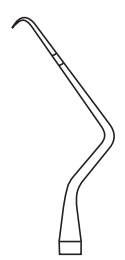

TS-7-5248
Fig. 24 K

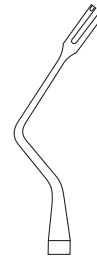

TS-7-5249
Fig. 27 K

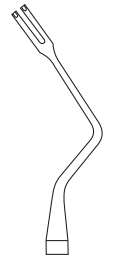

TS-7-5250
Fig. 28 K



TS-7-5251
Collin Tongue holding forceps
17 cm



Young Tongue holding forceps
TS-7-5252 15 cm
TS-7-5253 17 cm

TS-7-5254
Rubber Pad pair



TS-7-5255
Farabeuf 12 cm
Pair

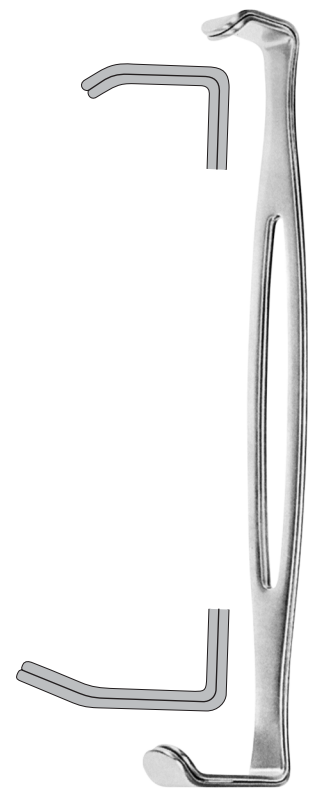

TS-7-5256
Parker-Langenbeck 21 cm
Pair



Osteotomes



15.5 cm

# 1	Diam.
0	Ø 1.60
7.5	Ø 1.80
10	Ø 2.00
13.5	Ø 2.40
15.5	Ø 3.60

1
Ø 1.6 mm



TS-7-5257
15.5 cm

# 2	Diam.
0	Ø 1.90
7.5	Ø 2.20
10	Ø 2.35
13.5	Ø 3.30
15.5	Ø 3.40
23.5	Ø 4.50

2
Ø 1.9 mm



TS-7-5258
15.5 cm

# 3	Diam.
0	Ø 2.80
7.5	Ø 3.20
10.5	Ø 3.35
13.5	Ø 3.60
21	Ø 4.40

3
Ø 2.8 mm



TS-7-5259
15.5 cm

# 4	Diam.
0	Ø 3.10
7.5	Ø 3.70
10.5	Ø 3.90
15.5	Ø 4.30

4
Ø 3.10 mm



TS-7-5260
15.5 cm

# 5	Diam.
0	Ø 3.90
10	Ø 5.00
13	Ø 5.20
20.5	Ø 6.30

5
Ø 3.90 mm



TS-7-5261
15.5 cm

# 6	Diam.
0	Ø 5.50
10	Ø 6.20
13	Ø 6.30

6
Ø 5.50 mm



TS-7-5262
15.5 cm

# 1	Diam.
0	Ø 1.50
5	Ø 1.90
8	Ø 2.20
10	Ø 2.40
12	Ø 2.60
14	Ø 2.80

1
Ø 1.5 mm



TS-7-5263
15.5 cm

# 2	Diam.
0	Ø 2.10
5	Ø 2.60
8	Ø 2.80
10	Ø 3.00
12	Ø 3.20
14	Ø 3.40

2
Ø 2.1 mm



TS-7-5264
15.5 cm

# 3	Diam.
0	Ø 2.60
5	Ø 3.00
8	Ø 3.30
10	Ø 3.50
12	Ø 3.70
14	Ø 3.90

3
Ø 2.6 mm



TS-7-5265
15.5 cm

# 4	Diam.
0	Ø 3.00
5	Ø 3.50
8	Ø 3.80
10	Ø 4.00
12	Ø 4.20
14	Ø 4.40

4
Ø 3.0 mm



TS-7-5266
15.5 cm

# 5	Diam.
0	Ø 3.50
5	Ø 3.90
8	Ø 4.20
10	Ø 4.40
12	Ø 4.60
14	Ø 4.80

5
Ø 3.5 mm



TS-7-5267
15.5 cm

Ø 2.8 mm



TS-7-5268
15.5 cm

Ø 3.5 mm



TS-7-5269
15.5 cm

Ø 4.2 mm



TS-7-5270
15.5 cm

Spelling Straight
Bone Pusher



Implantology Instrumetns

Osteotomes

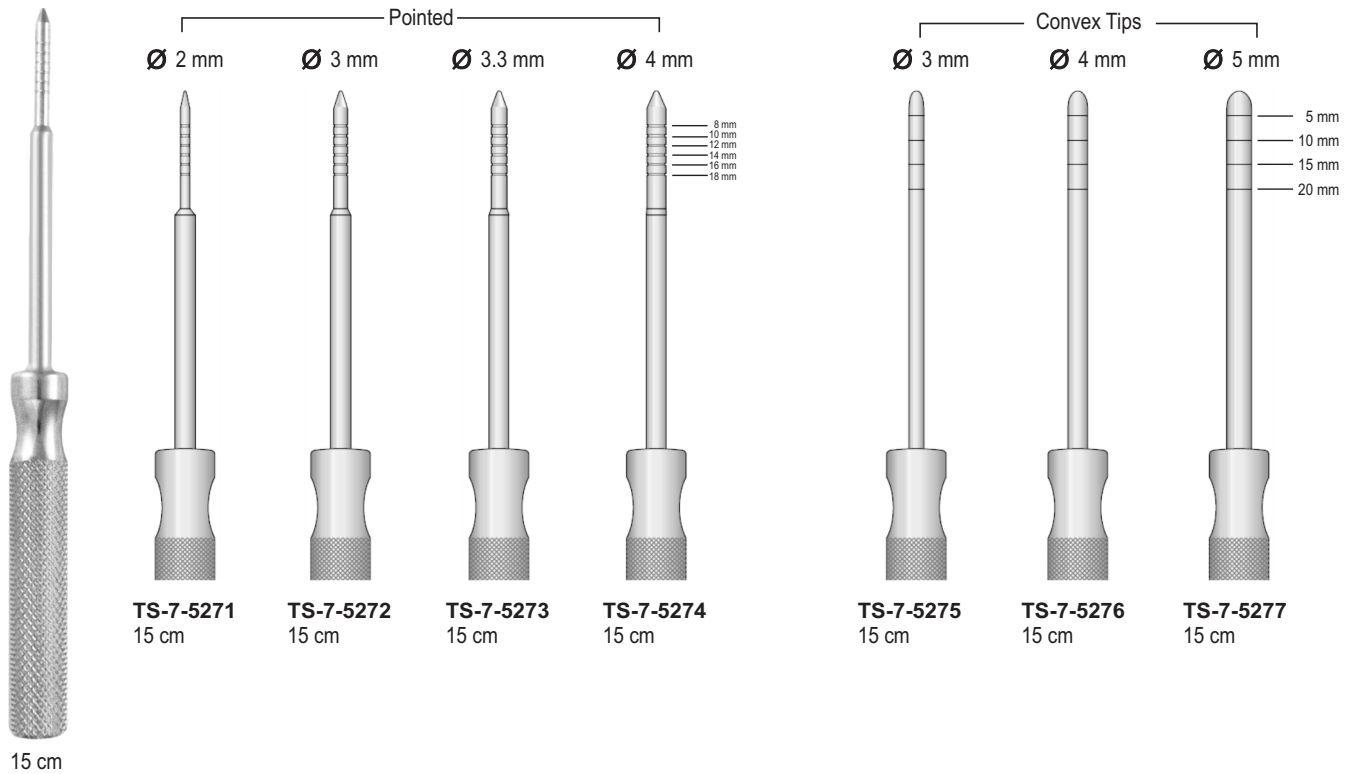

Convex Tips

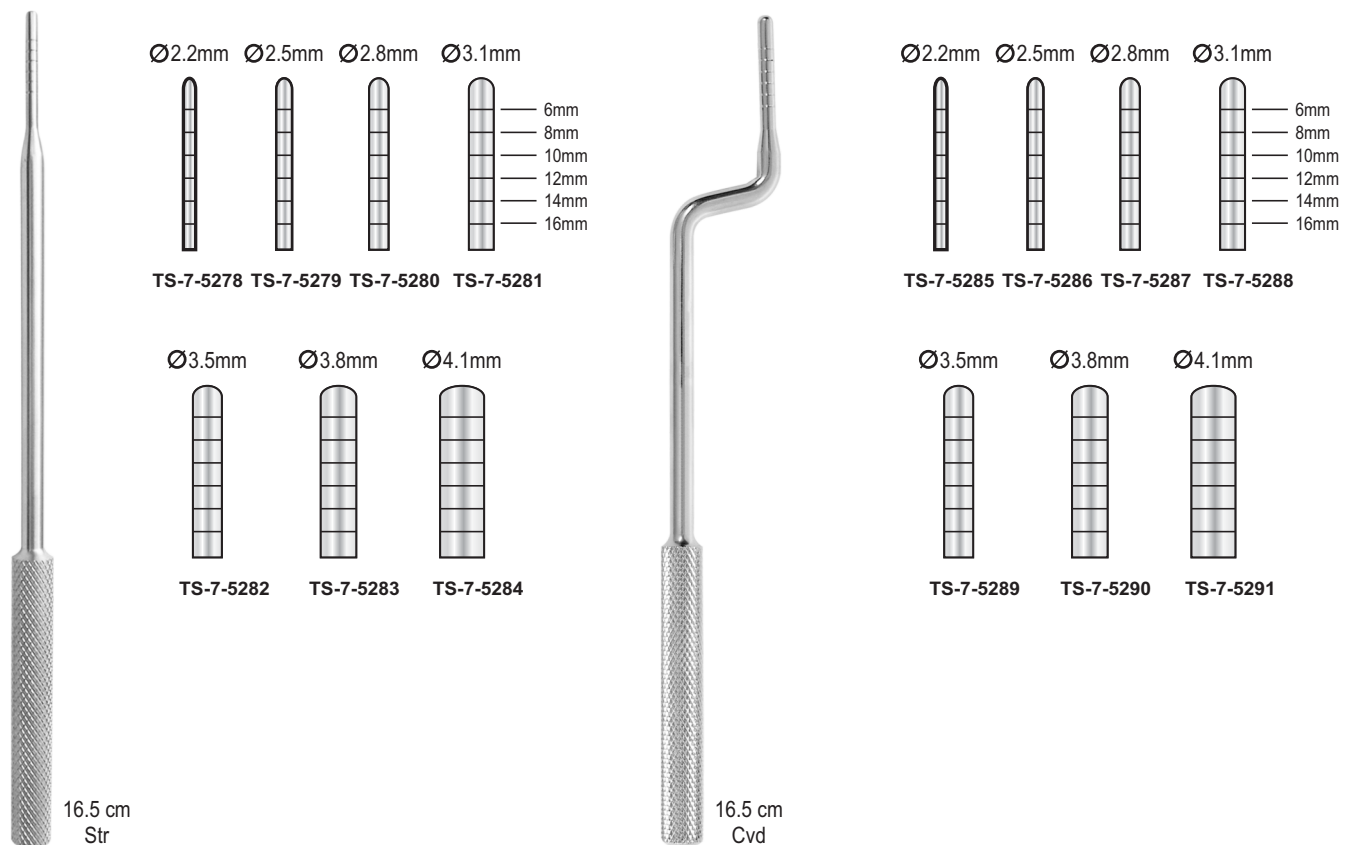



Osteotomes with Stop

Concave

Ø2mm Ø3mm Ø3.3mm Ø4mm

6mm
11mm
15mm

TS-7-5292 TS-7-5293 TS-7-5294 TS-7-5295

Convex

Ø2mm Ø3mm Ø3.3mm Ø4mm

6mm
11mm
15mm

TS-7-5296 TS-7-5297 TS-7-5298 TS-7-5299

Pointed

Ø2mm Ø3mm Ø3.3mm Ø4mm

6mm
11mm
15mm

TS-7-5300 TS-7-5301 TS-7-5302 TS-7-5303

16.5 cm Str

Osteotomes with Stop

Concave

Ø2mm Ø3mm Ø3.3mm Ø4mm

6mm
11mm
15mm

TS-7-5304 TS-7-5305 TS-7-5306 TS-7-5307

Convex

Ø2mm Ø3mm Ø3.3mm Ø4mm

6mm
11mm
15mm

TS-7-5308 TS-7-5309 TS-7-5310 TS-7-5311

Pointed

Ø2mm Ø3mm Ø3.3mm Ø4mm

6mm
11mm
15mm

TS-7-5312 TS-7-5313 TS-7-5314 TS-7-5315

16.5 cm Cvd

Osteotomes with Stop

Concave

Ø2.5mm Ø3mm Ø3.8mm Ø4.5mm Ø5mm

8mm
11mm
13mm
15mm
17mm
20mm

TS-7-5316 TS-7-5317 TS-7-5318 TS-7-5319 TS-7-5320

Convex

Ø2.5mm Ø3mm Ø3.8mm Ø4.5mm Ø5mm

8mm
11mm
13mm
15mm
17mm
20mm

TS-7-5321 TS-7-5322 TS-7-5323 TS-7-5324 TS-7-5325

Pointed

Ø2.5mm Ø3mm Ø3.8mm Ø4.5mm Ø5mm

8mm
11mm
13mm
15mm
17mm
20mm

TS-7-5326 TS-7-5327 TS-7-5328 TS-7-5329

16.5 cm Str

Osteotomes with Stop

Concave

Ø2.5mm Ø3mm Ø3.8mm Ø4.5mm Ø5mm

8mm
11mm
13mm
15mm
17mm
20mm

TS-7-5330 TS-7-5331 TS-7-5332 TS-7-5333 TS-7-5334

Convex

Ø2.5mm Ø3mm Ø3.8mm Ø4.5mm Ø5mm

8mm
11mm
13mm
15mm
17mm
20mm

TS-7-5335 TS-7-5336 TS-7-5337 TS-7-5338 TS-7-5339

Pointed

Ø2.5mm Ø3mm Ø3.8mm Ø4.5mm Ø5mm

8mm
11mm
13mm
15mm
17mm
20mm

TS-7-5340 TS-7-5341 TS-7-5342 TS-7-5343 TS-7-5344

16.5 cm Cvd



PDL Elevators



TS-7-5345 Distal, 2.5 mm Micro Edge

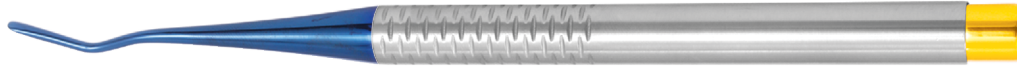

TS-7-5346 Mesial, 2.5 mm Micro Edge

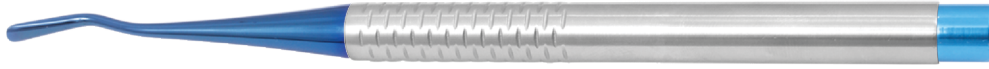

TS-7-5347 Distal, 4 mm Micro Edge



TS-7-5348 Mesial 4 mm Micro Edge



TS-7-5349 2.5 mm Micro Edge, Straight



TS-7-5350 2.5 mm Micro Edge, Curved



TS-7-5351 3.4 mm Straight

TS-7-5352 Set Of 7 Pieces



TS-7-5353 Distal, 2.5 mm Micro Edge



TS-7-5354 Mesial, 2.5 mm Micro Edge

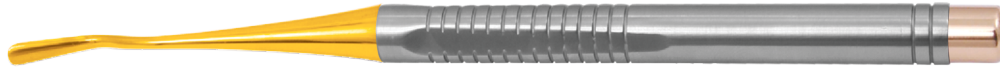

TS-7-5355 Distal, 4 mm Micro Edge

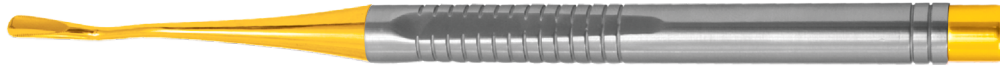

TS-7-5356 Mesial 4 mm Micro Edge



TS-7-5357 2.5 mm Micro Edge, Straight



TS-7-5358 2.5 mm Micro Edge, Curved



TS-7-5359 3.4 mm Straight

TS-7-5360 Set Of 7 Pieces



Instruments Tray



Trepine Drills



TS-7-5361
Interior 2 mm
Exterior 3 mm

TS-7-5362
Interior 3 mm
Exterior 4 mm

TS-7-5363
Interior 4 mm
Exterior 5 mm

TS-7-5364
Interior 5 mm
Exterior 6 mm

TS-7-5365
Interior 6 mm
Exterior 7 mm

TS-7-5366
Interior 7 mm
Exterior 8 mm

TS-7-5367
Interior 8 mm
Exterior 9 mm

TS-7-5368
Interior 9 mm
Exterior 10 mm



TS-7-5369
Trepine Drills Stand
Complete with drills



TS-7-5370
Trepine Drills Stand
Complete with drills

Tissue Punches



Keyes

TS-7-5371
2 mm

TS-7-5372
3 mm

TS-7-5373
4 mm

TS-7-5374
5 mm

TS-7-5375
6 mm

TS-7-5376
7 mm

TS-7-5377
8 mm



Keyes

TS-7-5378
3 mm

TS-7-5379
4 mm

TS-7-5380
5 mm

TS-7-5381
6 mm



Implantology Instrumentns

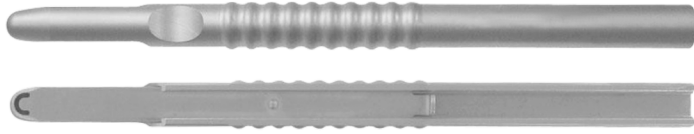

TS-7-5382
Bone Collector Chisel Straight



TS-7-5383
Blade for Straight bone collector chisel



TS-7-5384
Bone Collector Chisel Curved



TS-7-5385
Blade for Curved bone collector chisel



TS-7-5386
Ratchet Screw driver handle
Hexagonal head



TS-7-5387
Bone Morselizer with Titanium Grinding



TS-7-5388
Bone Mixing Basin
Dia 35 mm



TS-7-5389
Manual Easy Bone Mill



TS-7-5390
Bone Craker Titanium



Page
152-155

- Impression Trays

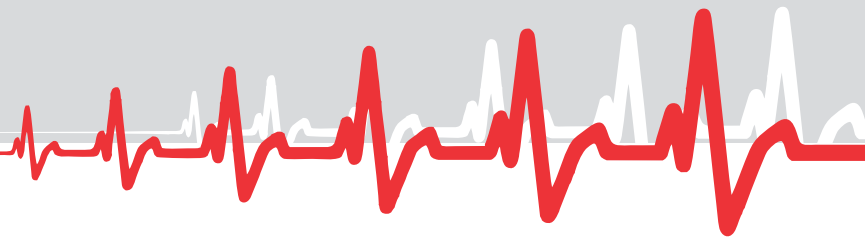



All Impression Trays Upper & Lower Type
are available in S, M, L & XL Sizes



TS-7-5391
"HYDRO-LOCK"
stainless steel
water-cooled
impression trays
with retention rim.



TS-7-5392
"HYDRO-LOCK"
stainless steel
water-cooled impression
trays with retention rim.



TS-7-5393
"NEW SUPER"
stainless steel
impression trays
with retention rim.



TS-7-5394
"NEW SUPER" stainless
steel impression trays
with retention rim.



TS-7-5395
"ANATOMIC" solid
regular stainless
steel impression
trays without
retention rim.



TS-7-5396
"ANATOMIC" solid regular
stainless steel impression
trays without retention rim.



TS-7-5397
Perforated-total denture
stainless steel
impression trays with rim.



TS-7-5398
Perforated-total denture
stainless steel
impression trays with rim.



Stainless Steel Impression Trays

All Impression Trays Upper & Lower Type are available in S, M, L & XL Sizes



TS-7-5399
"PERMA-LOCK" solid regular stainless steel impression trays with retention rim.



TS-7-5400
"PERMA-LOCK" solid regular stainless steel impression trays with retention rim.



TS-7-5401



TS-7-5402



TS-7-5403



TS-7-5404



TS-7-5405



TS-7-5406



TS-7-5407
Set of six

PACKINGS



TS-7-5408
Set of Eight



TS-7-5409
Solid stainless steel anterior depressed impression trays with retention rim.



TS-7-5410



TS-7-5411



TS-7-5412



TS-7-5413



TS-7-5414



TS-7-5415



TS-7-5416
Solid stainless steel anterior depressed impression trays with retention rim.



All Impression Trays Upper & Lower Type
are available in S, M, L & XL Sizes



TS-7-5417
Fig. 0 per bambini - for children

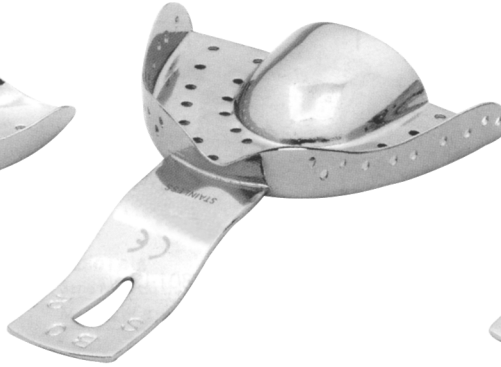

TS-7-5418
For narrow toothed upper jaws



TS-7-5419
Fig. 0 per bambini - for children



TS-7-5420
For partially toothed upper jaws



TS-7-5421
For partially toothed lower jaws



TS-7-5422
For edentulous upper jaws



TS-7-5423
For edentulous lower jaws



Stainless Steel Impression Trays

All Impression Trays Upper & Lower Type are available in S, M, L & XL Sizes



TS-7-5424
Solid total denture stainless steel impression tray with rim.



TS-7-5425
Solid total denture stainless steel impression tray with rim.



TS-7-5426
"PERMA-LOCK" perforated regular stainless steel impression trays with retention rim.



TS-7-5427
"PERMA-LOCK" perforated regular stainless steel impression trays with retention rim.



TS-7-5428
Perforated stainless steel anterior depressed impression trays with retention rim.



TS-7-5429



TS-7-5430



TS-7-5431



TS-7-5432



TS-7-5433



TS-7-5434



TS-7-5435
Perforated stainless steel anterior depressed impression trays with retention rim.



TS-7-5436
Perforated stainless steel impression trays without retention rim for complete denture.



TS-7-5437
Perforated stainless steel impression trays without retention rim for complete denture.



Page
156-157

- Arriculators

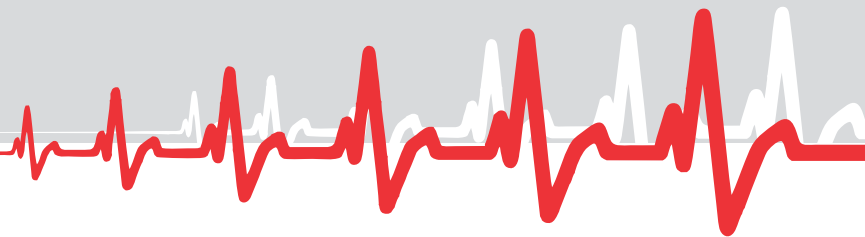

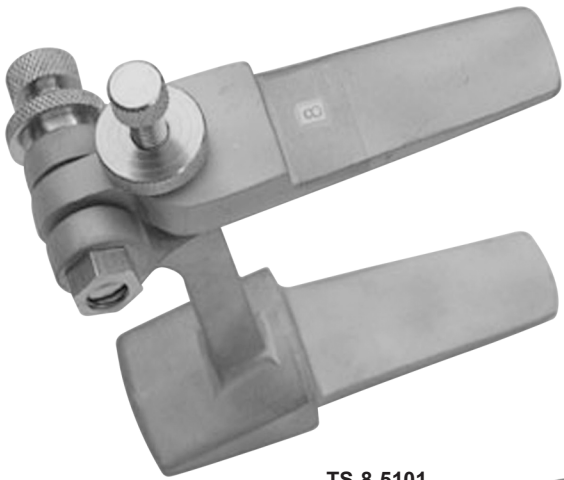

TS-8-5101



TS-8-5102



TS-8-5103



TS-8-5104

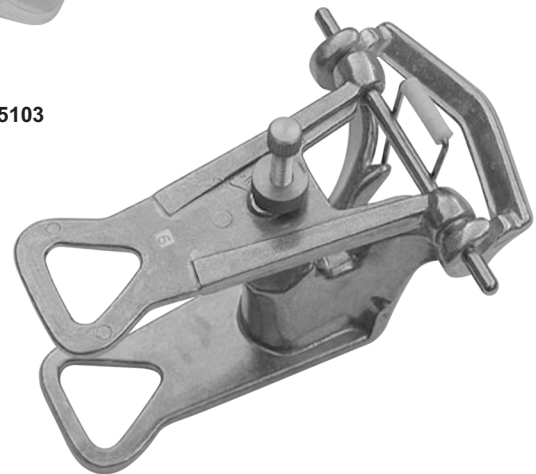

TS-8-5105



TS-8-5106



Articulators

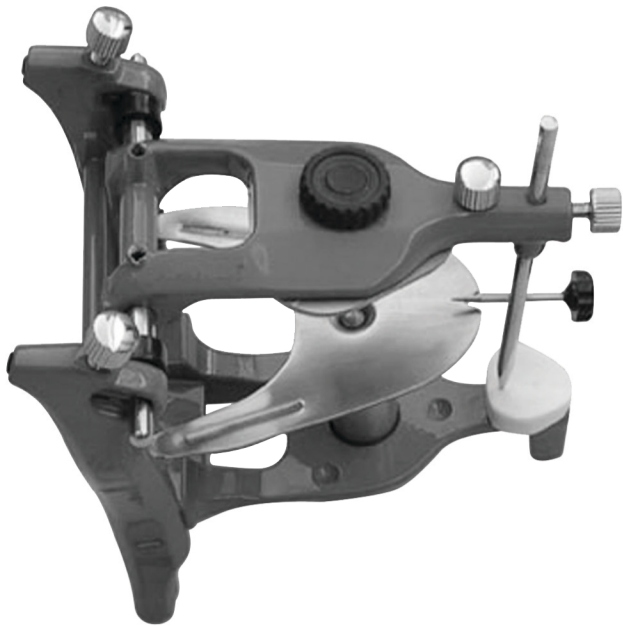

TS-8-5107



TS-8-5109



TS-8-5108



TS-8-5110



Page
158-160

- Dental Surgical Hollowares

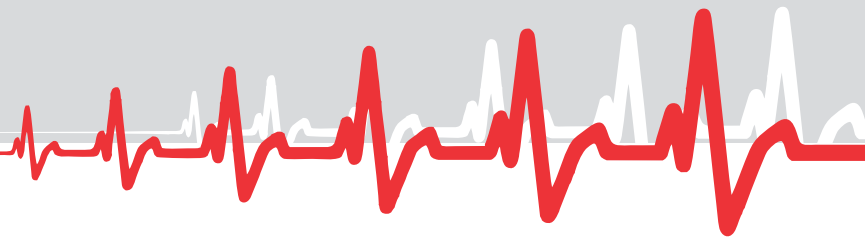

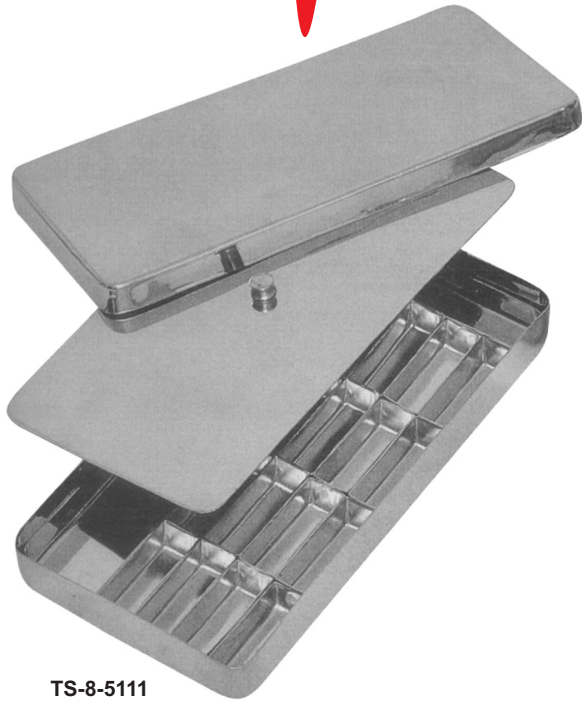

TS-8-5111
ENDODONTIC BOX



TS-8-5112
STERILIZING BOX
Available in dif. sizes
17x17x3 cm
20x10x4 cm
25x12x6 cm
30x14x6 cm



TS-8-5113
ENDO TRAY BOX

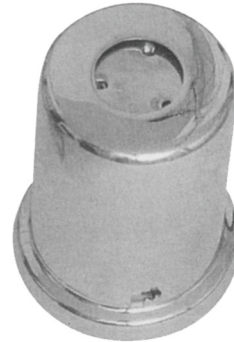

TS-8-5114
COTTON DISPENSER

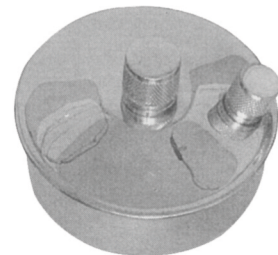

TS-8-5115
ALCOHOL LAMP

Sterilizing Drums



TS-8-5116



TS-8-5117



TS-8-5118



Sterilizing Boxes



TS-8-5119



TS-8-5120



TS-8-5121

Sterilizing Boxes



TS-8-5122



TS-8-5123



TS-8-5124



TS-8-5125

FORCEP AND THERMOMETER JARS



TS-8-5126

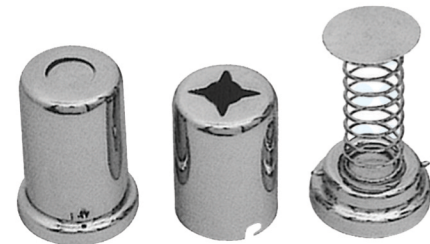

TS-8-5127

COTTON DISPENSER



TS-8-5128
IRRIGATOR(Douch can)



TS-8-5129
MEASURING JUG



TS-8-5130
KIDNEY TRAY



TS-8-5131
FORCEP JAR

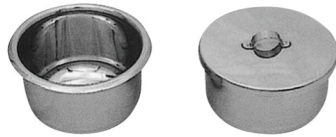

TS-8-5132
GALLIPOT WITH & WITHOUT LID



TS-8-5133
SPITTEN MUG



TS-8-5134
SPIRIT LAMP

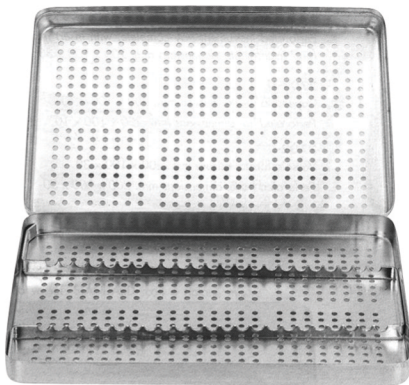

TS-8-5135
Perforated Tray



TS-8-5136
Perforated Base

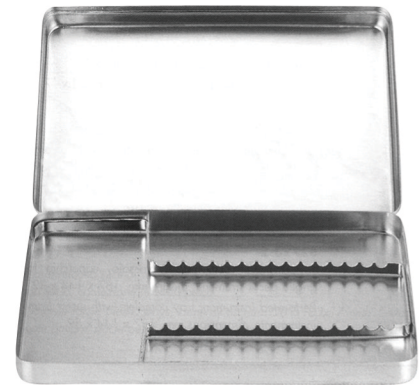

TS-8-5137
Solid Base



TS-8-5138
Instruments Tray



TS-8-5139
Instruments Tray



TS-8-5140
**Instruments Tray
(Perforated)**



TS-8-5141
**Instruments Tray Shallow
(Mayo)**



TS-8-5142
Scalers Tray



TS-8-5143
Cathetar Tray



Alphabetical Index

A					
Adams	125, 133	Cleveland	122	Goslee	134
Aderer	133	College	105, 107	Gouges	68
Adson	96	Columbia	64, 66, 74	Gracey Curettes	69
Ainsworth	110	Columbia	79	Gracey Mesial Distal	69
Albee	77	Cone-Socket	90	Gracey	56-69-72
Albrecht	109	Cork Screw Tip	104	Gritman	76-78-80
Alcohol Lamp	142	Cotton Dispenser	142, 143		
Alginate	93-94	Coupland	37		
Allen	109	Crane-kaplan	74	H	
Amalgam Carriers	117	Crile-Wood	96	Halstead-Mosquito	118
Amalgam Guns	117	Crown Removers	115-116	Hegar-Baumgartner	95-96
Amalgam Well	117	Cryer	35, 37, 48	Heidbrink	45-48-50
Andresen	134	Curette	64, 66	Heidemann	55
Angle	133			Hemingway	75
Antkoviak	78	D		Henahan	123
Apical	36, 44	De La Rosa	129	How	133
Arruga	97	Dental Probes	57	Hylin	40, 76
Articulators	140	Dental Syringes	103-104		
Ash	53, 88	Derf	95	I	
Aspirating Syringes	102	Didner	113	Impression Trays	136-139
				Intra-Ligamental Syringes	104
				Irrigator	143
				Ivory	110, 113
				Iwanson	77
B		E			
Band Adaptor	102	Eliselberg-Mathieu	97	J	
Barry	47, 50	Elliott	53	Jaquette	74
Baumgarthner	96	Endo Finger Ruler	102	Johnson	133
Beale	76	Endo Tray Box	142		
Beebee	116	Endodontic Box	142	K	
Bein	33, 40	Ermert	78	Kelly	118
Bennet	53, 123	Excavators	87-88	Kerrison	120
Beyer	121	Explorers	81	Kidney Tray	143
Bicuspids	114	Extracting Forceps	01-31	Kilian	124
Birdbeak Pliers	132			Kilian-Claus	124
Blumenthal	120, 121	F		Klein	07
Bohler	120	Fahnenstock	79	Kleinert-Kutz	121
Bohm	118	Filling Instruments	52-56	Kopp	39, 49, 108
Boley	77	Fischer	134		
Bone Chisels	68	Flagg	107	L	
Boynton	97	Flohr	38	Landgraf	107
Breech Loading Syringe	102	Forcepps Jar	143, 144	Langenbeck	134
Brewer	110	Fox	58	Le Cron	76
Buck	61-63, 65	Fraizer	100	Lecluse	43
Buckley	67, 124	Freer	123	Lessmann	79
Burnishers	58	Friedman	119-120	Lichtenberg	97
		Furrer	119	Listion-mini	122
C				London Hospital	41
Caroll	77	G		London-College	107, 109
Castroviejo	77, 98, 100	Gallipot	144	Lucas	75
Cathetar Tray	144	Gardner	67, 122	Luer	120
Cement Spatulas	91, 92	GF1	108	Luks	84
Chompret	44	GF2	108		
Ck1	108	Gillies	96		
CK2	108	Goldman Fox	60, 63, 65, 73, 120		



M			R			W		
Machtou	83		Rhodium	89		Wakefield		
Mallets	68		Roach	76		Waldron	67	
Mathieu	99, 100		Root Elevators	32--51		Waldsachs	133	
Matrix Bands	113, 114		Root Splinter	31		Warwick-James	130, 133	
Matrix Retainers	113		Root-Canal Excavators	86		Water Syringe	41	
Mayo-Hegar	95		Root-Canal Explorers	86		Weingart	101	
Mc Call	73		Root-Canal Plungers	84-85		White	129, 133	
Mc Kellops	133		Rubber Dam Clamps	111-112		Williams	52, 60, 83	
Mead	43, 58, 119		Rubber Dam Frame	110		Williger	123	
Measuring Jug	143		Ruskin-Mini	121		Winter	46, 50	
Measuring Plate	84					Woodson	54, 55	
Medicon	78		S			Y		
Meriam	106, 109		Scalers	58		Young	133	
Merrit A	60		Schell	119		Younger-Good	73	
Mershon	110, 116		Schilder	85				
Micro-Barraquer	99-100		Schluger	61, 62		Z		
Micro-Mosquito	118		Schwarz	134		Zahle	76	
Miller	118, 124		Seldin	34, 48, 123		Zaufal-Jansen	121	
Mini-Ryder	95		Spirit Lamp	144		Zerfing-Chisel	64, 66	
Molar	114		Spitten Mug	144		Zuricher	77	
Morell	116		Spreader	82-83				
Mouth Mirror Handles	89, 90		Sterilizing Boxes	142, 143				
Mouth Mirrors	89, 90		Sterilizing Drums	142				
MSY	76, 134		Sugarman	61, 162				
N			T					
Nabers	83		Taylor	74				
Nance	128, 133		Toennis	97				
Niro	122		Tofflemire	114				
			Tofflemire-Junior	113				
O								
Obwegeser	124		Tofflemire-Senior	113				
Ochsenbein	61, 62, 67		Tofflemire-Universal	113				
Olsen-Heger	96		Towner Jaquette	74				
Oms	83		Towner	74				
Ott	41		Trays	144				
			Treyman	116				
P								
P.K. Thomas	76		Tweed	130				
P.K. Thomas	68							
Partsch	134		U					
Pocket Probes	58-60		Univarsal "HM"	116				
Plaster Knives	80		Univarsal	128, 133				
Plaster Spatulas	93-94		University of Michigan	60				
Position Gauge	102		USA Model	133				
Pott	42							
R			V					
Rein	81		Vehe	76				
Relax	05		Vernier	77				
Reynolds	129		Vertical Condenser	83				
Rhodes	61, 62							



DENTAL instruments Catalogue

Address: Office# Roras Road Muzzafir Pur Near Ultra Surgical Sialkot
51310 Pakistan.

Office Phone: 0092-52 4590534

Whatsapp#: 0992-330 6152310

E-Mail: sales@tabmedinst.com

E-Mail: info@tabmedinst.com